



INTEGRATED ROLLER FIGURE SKATING DICTIONARY COMBINING PREVIOUS DANCE, FIGURE AND FREE SKATING DICTIONARIES

(Version 2006.10.15)



An Official Publication of
USA ROLLER SPORTS

Recognized by the United States Olympic Committee and the Federation International de Roller Sports (FIRS) as the National Governing Body for Competitive Roller Sports in the United States.

This book is fully protected by copyright and nothing that appears in it may be reprinted in any manner, either wholly or in part, for any use whatsoever, without special written permission of the copyright owner expressly permitting such reprint upon each and every occasion.

© 2006 USA Roller Sports
PO Box 6579, Lincoln, Nebraska 68506

"A" - In figure skating this denotes a right foot start.

A Position - A closed face-to-face relationship of partners where one partner progresses in a forward direction and the other partner progresses in a backward direction. The forward skating partner tracks the backward skating partner with hips in line and with compatible planning of head and shoulders. Transitional steps such as occur during face-to-face turns where both partners briefly progress in the same direction are not deviations from this position. When it is specified that a step be executed out of track while in a position it is referred to as Modified A position.

Accent - The emphasized beats in dance music. See the music section of the Dance Book for more details.

Adagio - A form of pairs team skating incorporating acrobatics, carries, pivots and other specialized movements not acceptable in competitive pairs skating.

Advanced Footwork - See Footwork.

Advanced Movement - Any movement involving a one-foot turn.

Aim - When the employed skate takes the floor on an arc or flat divergent to the arc or flat being skated (Dancers, see remarks on lobe aim.)

"And" Position - A position used in the preparation for a progressive stroke during which the free foot is placed alongside the skating foot.

Angular - (Aim) The skate to be employed taking the floor on an arc or flat divergent to the arc or flat being skated. A severely out-of-position broken line of the body.

Apex - (Free Skating) The highest or uppermost point of a jump. See Height.
(Figures) The peak of the arc being skated, always occurring on the long axis.

Arabesque - A movement in which the body is arched strongly in a continuous line from head through free foot while rolling on any edge or flat. Commonly called a "spiral."

Arc - The curve or portion of the circumference of a circle.

Arch - A position of the body in which the spine is tensed backward.

Artistic Impression - In competition, a score given by judges for the manner in which a routine is performed considering its sureness, carriage, rhythm, and timing of steps and items to the music. See Manner of Performance.

Axel - A 1 1/2 Turn Jump performed from a LOF take-off, counterclockwise rotation, to a ROB landing (no toe-stop assist on take-off or landing). Can also be done from a ROF take-off, clockwise rotation, to a LOB landing.
a. Single Axel - 1 1/2 turns in the air

b. Double Axel - 2 1/2 turns in the air
c. Triple Axel - 3 1/2 turns in the air

Axis - (Dance) The angle created by the intersection of a lobe and the dance baseline. The baseline of rotation for turns.

(Free Skating) An imaginary straight line about which a body rotates or revolves. The baseline of rotation for a spin or jump.

(Figure Skating plural axes) Imaginary lines of symmetry.

- a. Long Axis - An imaginary straight longitudinal line, which passes through the centers of the two or three figure circles.
- b. Short Axis - Imaginary straight lines which vertically cross the long axis at the points of tangency of the circle. Sometimes called the transverse axis.

"B" - In figure skating this denotes a left foot start.

B Position - An open side-by-side relationship of partners wherein both progress in the same direction, either forward or backward, while remaining square to their tracings. B Position is distinguished from Crossed Hands Position and D Position by the manner in which partner's hands are held.

a. Standard - The man skates on the left side of the team. The man's right arm is extended across the woman's back, partners clasping right hands at or near the woman's right hip. The woman's left arm is extended across man's chest, partners clasping left hands in a location between the man's waistline and shoulder line.

b. Reverse - The man skates on the right side of the team. The man's left arm is extended across the woman's back, partners clasping left hands at or near the woman's left hip. The woman's right arm is extended across the man's chest, partners clasping right hands in a location between the man's waistline and shoulder line.

Backward (B) - The tracing foot moving in the direction of its heel. Short version: back.

Background Music - A musical rendition played for a free skating/pairs program in which the skating is not related to the music.

Barrier - The outside wall, railing, or traffic line forming the boundaries of the skating surface.

Baseline - A real or imaginary reference line.

- a. Posture - An imaginary line from the center of the skating foot through the hip and shoulder lines.
- b. Team - An imaginary line forming the axis around which the members of a team rotate.
- c. Dance - The imaginary line on the skating surface around which the steps of a dance are patterned, and which separates center and barrier lobes. The pattern line of a dance.

Beat - A musical term; a regular throb or pulse of the music.

- a. Strong beat - A beat with heavy accent, often called the "down beat."

- b. Weak Beat - A beat with light accent.
- c. Off Beat - A beat without accent.

Boeckay - A 1 1/2 Turn Jump performed from a RIF take-off, counterclockwise rotation, to a LIB landing (no toe-stop assist on take-off or landing). Can also be done from a LIF take-off, clockwise rotation, to a RIB landing.

- a. Single Boeckay - 1 1/2 turns in the air
- b. Double Boeckay - 2 1/2 turns in the air
- c. Triple Boeckay - 3 1/2 turns in the air

Boeckl - A 1 1/2 Turn Jump performed from a RIF take-off, counterclockwise rotation, to a ROB landing (no toe-stop assist on take-off or landing). Can also be done from a LIF take-off, clockwise rotation, to a LOB landing.

- a. Single Boeckl - 1 1/2 turns in the air
- b. Double Boeckl - 2 1/2 turns in the air
- c. Triple Boeckl - 3 1/2 turns in the air

Border Dance - A dance whose steps have no required location on the skating surface. A dance skated so that the movement of the team changes the location of the steps on the surface.

Bracket (Br) - A one-foot turn involving a change of edge with the rotation counter to the direction of the initial edge.

Bridge - The arc between double threes.

Broken Ankle - A pivot spin variation in which the ankle is disjointed to the side of the skate and spun on the edge of the front and back wheels on the same side of the skate (only two wheels are in contact with the skating surface). The most common Broken Ankle spins are the IB Broken Ankle Camel (inside front and back wheels) and the OB Broken Ankle Camel (outside front and back wheels).

Bunny Hop - A jump, without rotation, from a LF to a LF with a right (r) toe-plant landing. Or can be done from a RF to a RF with a left (l) toe-plant landing. No edges required, but may be done on edges. The free leg swings forward on take-off. On landing, the toe-stop of the free foot takes the surface slightly ahead or alongside of the landing foot.

- a. Toe Bunny Hop - Starting on a RF with the left leg extended in front, the left toe-stop hits the skating surface while the right foot simultaneously slides forward. The jump is off the left toe-stop with the right leg extended forward in the air. The landing is on the right toe-stop pushing onto a LF. No edges required, but may be done on edges. Can also be done vice versa.
- b. Double Bunny Hop - Starting on a LF with the free leg extended in back, the right leg swings forward while jumping at the same time. The left leg scissors forward in the air. The landing is on the left toe-stop pushing onto a RF. No edges required, but may be done on edges. Can also be done vice versa.
- c. Back Bunny Hop - Same as the Bunny Hop except the movement is backward. The free leg swings backward on the take-off, the toe-stop of the free foot takes the surface slightly behind or alongside of the landing foot.

d. Back Toe Bunny Hop - Same as the Toe Bunny Hop except the movement is backward. Starting on a RB with the left leg extended in back, the left toe-stop hits the skating surface while the right foot simultaneously slides backward. The jump is off the left toe-stop with the right leg extended backward in the air. The landing is on the right toe-stop pushing onto a LB. No edges required, but may be done on edges. Can also be done vice versa.

C Position - A tandem relationship of partners (one behind the other) wherein both progress in the same direction either forward or backward with the man directly behind the woman. The trailing skater tracks the leading skater with hips in line and with compatible planing of head and shoulders.

Camel - See Spin.

Cannonball Tuck - See Tuck.

Carriage - The manner in which the body is held while skating.

Center -

1. The point around which a circle is described.
2. A point around which the body revolves, pivots, rotates, or turns.
3. The centerline of a rink, either real or imaginary.

Center Lobe - Any lobe belonging on the center side of a dance baseline.

Centered Spin - Series of continuous revolutions around a stationary axis, which passes through a portion of the body.

Championship - An official USARS sanctioned competition from which participants qualify to the next higher championship leading to the national and world competitions.

Change-Foot Spin - A spin that involves a change of feet. See Spin.

Change of Edge (C-E) - A change of curve from outside to inside, or vice versa, on one foot without a change of direction of the skate.

Chasse' - A step that does not pass the old tracing foot. A step, the completion of which does not involve or permit a trailing position of the foot, which is to become unemployed. The purpose of the chasse is to offset the forward motion of the body created by progressive runs. Thus the body is held erect with no forward or backward motion during the chasse.

- a. **Crossed** - A Chasse in which the free foot is placed on the floor crossed behind the engaged skate when skating forward and crossed in front when skating backward. The skate leaving the floor should not be lifted over the skating foot, but passed closely around the toe (or heel when backward) to the "and" position.

- b. **Dropped** (Cut Step) - A Chasse' during the execution of which the new free foot is moved against or into the line of travel.
- c. **Swing Dropped** - A dropped Chasse' where the free foot moves (past the employed foot) to the leading position before becoming the employed foot at the 'AND' position.
- d. **In Line** - A Chasse' for the execution of which the new tracing foot takes the surface in line with the old.
- e. **Raised** - A movement in which the free foot, during the period of becoming the skating foot, does not pass the original skating foot but is placed on the floor beside the skating foot with the new free foot remaining alongside the new skating foot, in most cases Chasse' are not more than one beat in length.

Cheated - A content item performed incorrectly while having the false appearance of correctness.

Checking - The intentional halting or decreasing of rotational momentum during a jump or spin. Also called Checking Out.

Choctaw - A two-foot turn from a forward edge to the opposite backward edge or vice versa.

- a. **Closed** - (American Dance) A Choctaw with the free leg in front of the body after the turn. In this type of turn, the free foot upon becoming employed progresses past the tracing foot. This type of turn is referred to as a progressive type turn.
(International Dance) A Choctaw in which the free foot is placed on the floor along the outer edge side of the skating foot at the heel. Following the weight transference, the position of the new free foot is in front of the toe of the skating foot. The final closed hip position gives this Choctaw its name.
- b. **Open** - A Choctaw with the free leg in front of the body after the turn. In the forward-to-back variety, the turn is executed heel to heel with the new free foot moving into the line of travel as the old free foot takes the floor. In the back-to-forward variety, the turn is executed from behind the heel, with the free leg trailing after the turn. This type of turn is referred to as a chasse'-type turn.
- c. **Dropped** - A Choctaw, either open or closed, where the second or turn edge is not held longer than one beat.
- d. **Held** - A Choctaw, either open or closed, the second, or turn edge, of which is held longer than one beat of music.
- e. **Swing Choctaw** - A Choctaw in which the free foot is swung forward passed the skating foot and is brought back close behind the skating foot before stepping down. It may be either an open or closed Choctaw depending on where the new skating foot takes the floor and the position (open or closed) of the new free hip.

Choctaw Jump - A Two Foot, Half Turn Jump from a forward edge to the opposite backward edge, or vice versa. Can be performed with either counterclockwise or clockwise rotation in the air.

Choreography - The composition and arrangement of jumps, spins, and footwork on the skating surface

accompanied by a particular piece or pieces of music which evokes the character of the movements.

Chugging - A tracing error in which the body weight shifts from the front to the back of the skate, or vice versa, thereby impeding purity of roll.

Circle Spin - See Spin.

Clean - A content item performed correctly according to its official description.

Clockwise - Rotation in the direction which the hands of a clock rotate.

Closed -

- a. A position of the free leg in front of the body.
- b. Hip rotation of the free leg inward.
- c. (Dance) A face-to-face position of partners.
- d. (Competition) Requiring prior qualification.

Closed Scoring - A method of scoring in which the judges' grades are tabulated by the scoring officials without prior public display or announcement of grades or placement ordinals.

Closed Competition - A competition requiring prior qualification.

Colledge - A 1 1/2 Turn Jump performed from a LOF take-off, counterclockwise rotation, to a LIB landing (no toe-stop assist on take-off or landing). Can also be done from a ROF take-off, clockwise rotation, to a RIB landing. Also called a Colledge Axel.

- a. Single Colledge - 1 1/2 turns in the air
- b. Double Colledge - 2 1/2 turns in the air
- c. Triple Colledge - 3 1/2 turns in the air

Combination - A sequence of connected items performed in succession without interruption.

Combination Jump - See Jump.

Combination Spin - See Spin.

Complete - Executed successfully. Possessing all necessary parts, items, components, or elements. Not lacking anything necessary. Finished.

Composition - The order or arrangement of items in a free skating/pairs program in proper proportion or relation to the whole skating surface.

Competition - A USARS sanctioned contest among skaters.

Concentric Rotation - See Rotation.

Connecting Jump - See Jump.

Connecting Movements - Footwork which links together content items in a free skating/pairs program.

Contact Skating - In pairs, movements executed while partners remain in contact with each other.

Content of Program - The actual items or ingredients performed by a skater in a free skating/pairs program. See Technical Merit.

Contest - Skaters performing before judges for placement in order of skill. A competition in which each contestant performs without direct contact with or interference from competitors.

Contestant - Any skater who participates in one or more events of a contest.

Contestant Team - Any two skaters who participate in one or more events of a contest as a unit, as required by the specific rules for the given contest.

Continuous Baseline - A real or imaginary line, which is continuous around the skating surface, in relation to which the correct lobes (and/or flats) of a Border Dance are placed. In patterns with straight-aways, this portion of the continuous baseline would have two straight longitudinal references parallel to each other, which are connected at the ends with semi-circular type reference.

Cork Screw - An IB Sit to IB Camel Combination Spin. Usually preceded by another Camel.

Corner - The area of a skating surface permitting the shortest linear dimension parallel to the barrier, or at right angles to the straightaway. The area of a skating surface of least length. That part of a dance that is to be skated only in the area of a skating surface of least length. That part of a dance specifically designed to connect one straightaway with the other.

Corner Steps - Steps of a dance, which are to be skated only on the corners of the rink.

Count -

- a. Music - The numerical reference to the beats of each measure of music.
- b. Skating - The numerical reference to the beats of a step which may or may not agree with the musician's count.

Counter (Co) - A one-foot turn without a change of edge with the rotation counter to the direction of the initial edge.

Counterclockwise - Rotation in the opposite direction which the hands of a clock rotate.

Credit - An acknowledgement that something is done well. Usually reflected in a higher score given by a judge.

Cross Cut - Term used for a forward Cross Over or a backward Cross Pull.

Cross Over - A means of gaining momentum skating forward by crossing the free foot (striking foot) in front of the employed foot (thrusting foot) while bending the striking

knee and straightening the thrusting knee. Also called Stroking.

Cross Pull -

- a. (Free Skating) A means of gaining momentum skating backward by reaching wide and drawing the free foot skate behind and across the employed skate. The crossing skate is in a leading position. This movement is performed on bent knees with or without rise-and-fall. The employed skate remains the same throughout the movement.
- b. (Figures) A primary source of momentum in which the free foot is pulled or forced across the tracing foot, i.e., steering.

Cross Roll - See Roll.

Cross Stroke - (International Dance) a step started with the feet crossed when the impetus is gained from the outside edge of the foot, which is becoming the free foot.

Crossed Arms Position - See H Position.

Crossed Foot Spin - See Spin.

Crossed Step -

- a. Forward (XF) - A step in which the free foot is placed on the floor along the outer edge side of the skating foot with the calf of the free leg crossed in front of the shin of the skating leg.
- b. Behind (XB) - A step in which the free foot is placed on the floor along the outer edge side of the skating foot with the shin of the free leg crossed behind the calf of the skating leg.

Crossed Tracing

- a. (Dance) - Tracing of succeeding steps on overlapping arcs, either convergent or concentric.
- b. (Figures) - An error in which the free leg or free foot is carried across the tracing.

Crown - The deepest arc of a loop.

Curtsy - A two foot movement where the two front wheels of the trailing skate are touched to the floor directly behind and tracking the heel of the leading skate.

Cusp -

- a. The point of any one-foot turn.
- b. (Figures) - The point of intersection of, and the two small curves, comprising the deviation from the arc. The size of the cusp for a three turn is one skate length. The size of the cusp for brackets, rockers, and counters is 'a skate length'.

Cut-offs - A forward Half Turn Mohawk or Choctaw Jump with the landing leg crossed in front of the free leg.

Cut Step (Dropped Chasse) - A Chasse' during the execution of which the new free foot is moved against or into the line of travel.

D Position - An open side by side open relationship of partners wherein both progress in the same direction,

forward or backward as square as possible to the tracing. D Position is distinguished from B Position and Crossed Arms Position by the handhold, and from E Position by the requirement that both partners face toward their clasped hands. The man is to the left of the team and holds the woman's right hand in his left hand in a leading position. The man's right hand is on the woman's back and the woman's left hand is on the man's back with her left arm outside his right arm.

Dance Positions

International

1. Closed or Waltz Position A:

Partners face each other directly, one skating forward while the other skates backwards. The man's right hand is placed firmly against his partner's back at her shoulder blade with elbow raised and bent sufficiently to hold her close. The woman's left hand is placed against the man's right shoulder with her arm resting comfortably on his, elbow to elbow. The man's left arm and * woman's right arm are extended at average shoulder height. The shoulders are parallel.

2. Killian or Side B Position:

Partners face in the same direction, woman at the right of the man, man's right shoulder behind woman's left. Woman's left arm is extended in front across man's body to his left hand, while his right arm is behind her back. Both right hands clasped and resting at her waist over hip bone. This position may also be reversed, with the man at the right of the woman, both hands clasped and resting at her waist over the left hip bone.

3. Tandem Position C:

Skaters positioned directly behind each other, skating identical edges. Hold can be either both hands for both skaters, on woman's waist, or one hand on woman's waist (both skaters) with the other one outstretched.

4. Foxtrot or Open D Position:

Hand and arm positions are similar to those of the Closed position, but the partners turn slightly so that both may skate in the same direction. The man's left hand and the woman's right hand lead. This position may also be reversed, with the man on the woman's right side.

5. Trailing Foxtrot or Trailing Open E:

Same as the Foxtrot or Open D, except that the clasped leading hands are reversed, following the couple rather than leading the couple.

6. Side Closed or Tango F:

Partners face in the same direction, one skating forward while the other skates

backwards. Unlike the Closed A position, partners skate hip to hip, the man either to the right or left (Reversed F) of the woman.

7. Hand-in-Hand Position G:

Partners face in the same direction and are side by side with arms comfortably extended, the man's right hand in his partner's left. The woman is on the right side unless otherwise noted.

8. Crossed Arms H:

Same as the Killian B position, except that rather than being on the woman's right hip, the man's right hand is placed in front of the woman and both partners clasp hands close to the woman's torso.

Dayney - A Full Turn Jump from a LOB take-off, counterclockwise rotation, to a ROB landing (no toe-stop assist on take-off or landing). Can also be done from a ROB take-off, clockwise rotation, to a LOB landing. Also called a Toeless Lutz.

Definition - Applies to turns, threes, brackets, rockers, counters; meaning two equal spirals (curves or edges) which point the turn in the proper direction and on the proper edge. (Example: A turn has definition when it points in the proper direction with equal curves and proper edges.)

Degree of Difficulty - The level of skill needed to perform an item well (or correctly) relative to other items of the same kind.

Diagram - A drawn or printed pattern. The official print of a dance or figure.

Direction -

- Direction of edge - clockwise or counterclockwise progression of a curve.
- Direction of rotation - turning of the body in a clockwise or counterclockwise direction.
- Direction of skate - forward or backward progression of a skate.
- Direction of travel - the general direction of a skater or team of skaters, either clockwise or counterclockwise around the rink.
- Direction of turn - clockwise or counterclockwise rotation during a turn.
- Forward - The body facing toward the direction of travel.
- Backward - The body facing away from the direction of travel.

Division of Competition - The class and branch of the sport for a contest.

Double Jump - See Jump.

Double Three -

- Two consecutive three turns on the same foot and the same arc. (Each turn being one skate length in depth)

- b) Two three turns on the same Figure circle, remaining on one foot, with the turns dividing the circle into thirds.

Double Repetition - Skating a figure two consecutive times without pause, completed by the stroke into the third repetition or by rolling off the circle at the short axis, having completed two tracings.

Draw - Movement of the free leg in preparation for a turn on steps not permitting swings. Draw is used only on steps of four beats or longer during which rotation or preparation for a turn must be made.

Drawing Procedure - The method by which the skating order of the contestants or contestant teams is to be and is determined, as prescribed by rule.

Dropped - Not held longer than one beat of music. See Choctaw, Mohawk, Three, Turn, and Chasse' for specific classifications.

E Position - A closed side by side relationship of partners wherein both progress in the same direction, forward or backward. E Position is distinguished from D Position by the requirement that partners face away from their clasped hands. Man is to the right of team, with handclasp and position of contact identical to D Position. The clasped hands may be held in either a trailing or leading position.

Eagle - See Spread Eagle.

Edge - A constant curve traced by the employed skate, with constant lean and weight to the center of the arc or circle being skated. The eight prescribed edges in roller skating (in alphabetical order):

1. LIB (Left Inner Back) - Counterclockwise curve of a backward tracing left skate.
2. LIF (Left Inner Forward) - Clockwise curve of a forward tracing left skate.
3. LOB (Left Outer Back) - Clockwise curve of a backward tracing left skate.
4. LOF (Left Outer Forward) - Counterclockwise curve of a forward tracing left skate.
5. RIB (Right Inner Back) - Clockwise curve of a of a backward tracing right skate.
6. RIF (Right Inner Forward) - Counterclockwise curve of a forward tracing right skate.
7. ROB (Right Outer Back) - Counterclockwise curve of a backward tracing right skate.
8. ROF (Right Outer Forward) - Clockwise curve of a forward tracing right skate.

Edge Hooked - An abruptly deepened curve.

Edge Spin - See Spin.

Employed - In use. Tracing.

- a. Employed Foot - The foot and skate in contact with the surface, carrying the body weight.
- b. Employed Leg - The leg of the employed foot.

c. Employed Skate - The skate in contact with the skating surface or if both feet are on the surface, the skate that carries the weight of the body. The tracing skate.

Entry - The beginning of an item.

Euler - A Full Turn Jump from a ROB take-off, counterclockwise rotation, to a LIB landing (no toe-stop assist on take-off or landing). Can also be done from a LOB take-off, clockwise rotation, to a RIB landing. Also called a Loop Step when used as a Connecting Jump in a Combination.

Event - Any one part of a contest; elimination, semi-final, or final or any subdivision in the skating of a contest, but not the performance by each individual entry.

Excessive Lift - A movement, which carries the entire, body and skates higher than just slight elevation off the floor during footwork movements. Obvious jumping effort.

Exit - The finishing of an item.

F Position - A closed side by side relationship of partners where one progresses in a forward direction while the other progresses in a backward direction, with the bodies carried out of direction alignment and not tracking.

- a. Standard - The man is to woman's right, his right shoulder and hip alongside and as close as practical to the woman's right shoulder and hip.
- b. Reverse - The man is to woman's left, his left shoulder and hip alongside and as close as practical to the woman's left shoulder and hip.

Fall - The lowering of the body by action of the tracing knee and ankle. The complete loss of balance involving body contact with the skating surface.

False Lean - Lean without maintaining a straight posture baseline.

Figure - A prescribed movement symmetrically composed of at least two circles, but not more than three circles, involving primary, or primary and secondary movements, with or without turns. Figures are skated on circles, which have been inscribed on the skating surface.

Flat - No edge or edges. A straight line traced by the employed skate. A term used for four wheels rolling on the skating surface with no curvature of the skate. In spinning, the term used for four wheels sliding on the skating surface.

Flat Back - A slang term, which describes the correct and completed landing of any backward, landing jump (without a hook, toe-stop assist, or cheat of any kind). A backward landing, which is completed on the same arc on four wheels on the prescribed edge according to the official description of the jump.

Flight - The skating of two, three, or four teams at the same time in an event of a dance contest. Groupings of the

contestant teams in a dance contest. The trajectory of a jump. The component of a jump in which the skater is airborne.

Flip - A Full Turn Jump from a LIB take-off with a right (r) toe-plant, counterclockwise rotation, to a ROB landing (no toe-plant on the landing). Can also be done from a RIB take-off with a left (l) toe-plant, clockwise rotation, and a LOB landing.

Floor - See Skating Surface.

Flow - An unimpeded motion that proceeds smoothly and evenly without apparent effort.

Following - In the direction, which has been traced. The next step in a sequence. Acceptance by one partner of the harmonious relationship with the lead partner.

Footwork - Specialized intricate steps used as an interpretive ingredient of a free skating/pairs program. See also Link Step.

- a. Primary Footwork - Footwork not using turns as an ingredient.
- b. Secondary Footwork - Footwork using two-foot turns as an ingredient.
- c. Advanced Footwork - Footwork using one-foot turns as an ingredient.

Forced Edge - Tracing made with the weight outside the arc, or with the ankle dropped.

Form - Posture, carriage, flow and motion reflecting smoothness and ease of performance while dancing, jumping, spinning and skating footwork.

Forward (F) - The tracing foot moving in the direction of its toes.

Free - Not in use. Not in contact with the skating surface, or not carrying the weight of the body. Unemployed.

Free Skating - Individual and original composition of movement and pattern permitting complete freedom as to style and content. The basic movements in a free skating program consist of jumps, spins, and footwork, which are blended, in harmony with the skater's choice of music.

Free Style - See Free Skating.

Full Stroke - See Stroke.

Full Turn Jump - See Jump.

G Position - A side-by-side relationship of partners used as a starting position and continued only for the opening steps of a dance. Man may be either to the right or left of the team. If to the left, man clasps woman's left hand in his right hand, with unclasped hands held to the side; if to the right, man clasps woman's right hand in his left hand. Also referred to as the hand in hand position.

Glide - An uninterrupted flowing motion.

Grade - The numerical value assigned to a competitive requirement by an individual judge. See Integer System.

Grip - The method of hand contact in the various hold positions. For Dance these will be:

- a. Standard - The established or prescribed method of hand contact for any given position.
- b. Thumb Pivot Grip - A method of hand contact wherein the man to permit a change from B Position to Reverse B Position without a change of grip and without releasing contact clasps the woman's thumbs. Identical side-by-side turns may be executed in this position without changing relation of partners to the pattern.
- c. Cross Arms - A method of hand contact which permits oppositely rotated but compatible turns to be executed without changing the relation of partners to the pattern of a dance. See H Position.
- d. Tandem - The modification of standard B hold permitting the man to skate directly behind the woman. The woman brings her right hand up to a position directly in front of her right shoulder. The man's right hand clasps the woman's right hand with his forearm and wrist directly at the woman's right armpit.

H Position - A side-by-side relationship of partners wherein both progress in the same direction, forward and backward. H Position is distinguished from B and D Positions only by the handhold. The man may be on either side of the team without the position being considered reversed. Arms of both partners are crossed in front of the bodies, right hands and left hands clasped palm to palm with fingers holding wrists, not in hand shaking grip.

Half Dayney - A Half Turn Jump from a LOB take-off, counterclockwise rotation, and the option of a left (l) toe-plant to RIF landing or a right (r) toe-plant to a LOF landing. Can also be done from a ROB take-off, clockwise rotation, and the option of either a right (r) toe-plant to a LIF landing or a left (l) toe-plant to a ROF landing.

Half Flip - A Half Turn Jump from a LIB take-off with a right (r) toe-plant, counterclockwise rotation, and the option of a left (l) toe-plant to RIF landing or a right (r) toe-plant to a LOF landing. Can also be done from a RIB take-off with a left (l) toe-plant, clockwise rotation, and the option of either a right (r) toe-plant to a LIF landing or a left (l) toe-plant to a ROF landing.

Half Loop - A Half Turn Jump from a ROB take-off, counterclockwise rotation, and the option of a left (l) toe-plant to RIF landing or a right (r) toe-plant to a LOF landing. Can also be done from a LOB take-off, clockwise rotation, and the option of either a right (r) toe-plant to a LIF landing or a left (l) toe-plant to a ROF landing.

Half Lutz - A Half Turn Jump from a LOB take-off with a right (r) toe-plant, counterclockwise rotation, and the option of a left (l) toe-plant to RIF landing or a right (r) toe-plant to a LOF landing. Can also be done from a ROB take-

off with a left (l) toe-plant, clockwise rotation, and the option of either a right (r) toe-plant to a LIF landing or a left (l) toe-plant to a ROF landing.

Half Mapes - A Half Turn Jump from a ROB take-off with a left (l) toe-plant, counterclockwise rotation, and the option of a left (l) toe-plant to RIF landing or a right (r) toe-plant to a LOF landing. Can also be done from a LOB take-off with a right (r) toe-plant, clockwise rotation, and the option of either a right (r) toe-plant to a LIF landing or a left (l) toe-plant to a ROF landing.

Half Salchow - A Half Turn Jump from a LIB take-off, counterclockwise rotation, and the option of a left (l) toe-plant to RIF landing or a right (r) toe-plant to a LOF landing. Can also be done from a RIB take-off, clockwise rotation, and the option of either a right (r) toe-plant to a LIF landing or a left (l) toe-plant to a ROF landing.

Half Toe Walley - A Half Turn Jump from a RIB take-off with a left (l) toe-plant, counterclockwise rotation, and the option of a left (l) toe-plant to RIF landing or a right (r) toe-plant to a LOF landing. Can also be done from a LIB take-off with a right (r) toe-plant, clockwise rotation, and the option of either a right (r) toe-plant to a LIF landing or a left (l) toe-plant to a ROF landing.

Half Turn Jump - See Jump.

Heel-and-Toe - See Spin.

Heel Spin - A pivot spin variation in which the toe wheels are lifted off the floor and the heel wheels pivot at the center of the spinning circle.

Height - The highest point the body travels above the skating surface during the flight of a jump. The apex of a jump.

Held - Employed for longer than one beat of music. See Choctaw, Mohawk, Three, and Turn.

High Wrap - The body position during the flight of a jump in which the legs are crossed and the free foot rises above the employed knee.

Hitching - An incorrect movement of the employed skate which involves skidding the leading wheel in order to assist a take-off, execute a turn, or conform to a designated pattern.

Hold - The relationship of man and woman to each other in partnership without regard to method of hand contact. For dance definitions of each hold, see A Position, B Position, C Position, D Position, E Position, F Position, G Position, and H Position.

Hook - A term used to describe the action of the employed skate during the take-off and/or landing of a jump which resembles the shape of a "J". The tracing skate creates a sharp half-arc at the beginning or the ending of an edge.

Hooked Edge - An abruptly deepened curve.

Hop - A jump, without rotation, which involves a toe-plant on the take-off and/or landing.

Hyper-extension - The over-straightening of a flexed limb.

IB (Inner Back) - The curvature or slide of a backward tracing skate in the direction of the inside of the foot. Also called a Back Inside.

IF (Inner Forward) - The curvature or slide of a forward tracing skate in the direction of the inside of the foot. Also called a Forward Inside.

Incomplete - A figure in which the skater does not perform all of the prescribed parts.

Inner (abr. I) - A curve wherein the inside of the foot (big toe side) is toward the center of the curve being skated. Also called an Inside Edge.

Inside - See Inner.

Inside Edge - A curve wherein the inside of the foot (big toe side) is toward the center of the curve being skated.

Inside Landing - See Landing.

Integer - A whole number.

Integer System - The official grading system for competition utilizing whole numbers from 0 to 100 without the use of any fractions or factors. See Score.

Interpretation - A display of understanding of the music used by the skater. This is the individual's movements in harmony with the rhythm, tempo, and mood of the program's music.

Interpretive Movement –

1. A movement, which imparts feeling or character to a free skating/pairs item.
2. A series of steps or chain of footwork or movements which impart feeling or character to a routine, when a musical rendition which, because of its pace, mood, or accent lends itself to a performance of individual character or feeling.

Interpretive Routine - A composition of skating movements, which bear a positive and identifiable relationship to the music used.

Inverted Camel - A spin variation in the Camel position with hips and shoulders frontside facing up.

Item - A single movement of a free skating/pairs program.

Judge - An official commissioned to determine the value of a skater's performance, or to assign an order of placement to contestants or contestant teams in a contest according to the level of skill.

Jump - A movement, which carries the entire body and skates off the skating surface.

1. Standard Jump - Any jump with a generally accepted name or official description.

a. Half Turn Jump - A jump employing 180 degrees of rotation (1/2 turn in the air).

b. Full Turn Jump (Single Jump) - A jump employing 360 degrees of rotation (1 turn in the air).

c. 1 1/2 Turn Jump - A jump employing 540 degrees of rotation (1 1/2 turns in the air).

d. Double Jump - Any Single Jump with 1 full turn added. A jump employing 720 degrees of rotation (2 turns in the air).

e. 2 1/2 Turn Jump - A jump employing 900 degrees of rotation (2 1/2 turns in the air).

f. Triple Jump - Any Single Jump with 2 full turns added. A jump employing 1080 degrees of rotation (3 turns in the air).

g. 3 1/2 Turn Jump - A jump employing 1260 degrees of rotation (3 1/2 turns in the air).

h. Quadruple Jump - Any Single Jump with 3 full turns added. A jump employing 1440 degrees of rotation (4 turns in the air).

2. Combination Jump - An item, which contains a succession of two or more jumps in which the landing edge of each jump is the take-off edge of the following jump.

3. Jump Series - A succession of jumps in a row similar in appearance to a Combination with the exception that turns, changes-of-edge, footwork or other items are performed between any of the jumps.

4. Connecting Jump - A Single Jump that is used as a link to jumps with more than one rotation in a Combination.

5. Set-Up Jump - A Half Turn Jump used to prepare the rhythm, body position, and take-off edge of a subsequent jump of higher difficulty.

6. Step Jump - A Half Turn Jump from one foot to the other foot without excessive lift, toe-plant, or toe-stop assist.

7. Jump Variation - Any hop, leap, or jump that is out-of-the-ordinary or may not be a listed standard jump. Also, any standard or recognized jump with varied arm and/or leg positions which are visually pleasing and musically interpretive.

Jump Series - See Jump.

Jump Spins - See Spin.

Jump Variation - See Jump.

Landing - the concluding and final component parts of any jump, leap, or hop.

1. Landing Skate - The skate that traces the prescribed exit edge of any jump, leap, or hop.

2. Landing Edge - The edge traced by the landing skate.

3. Landing Foot - The foot of the landing skate.

4. Landing Position - The form of the body during a landing.

5. Outside Landing - Landing skate tracing an outside edge.

6. Inside Landing - Landing skate tracing an inside edge.

Layover Camel - A spin variation in the Camel position with the shoulder line and hipline perpendicular to the skating surface in the open position.

Leading - In the direction to be traced. In position to control or the act of controlling the execution of a team movement.

Leading Partner - The member of the team in position to control the movement skated.

Lean - The inclination of the body to either side of the vertical.

a. True Lean - Lean with a posture baseline.

b. False Lean - Lean without a posture baseline.

Leap - A jump, without rotation, which does not involve a toe-plant or toe-stop assist on the take-off or landing.

LIB (Left Inner Back) - See Edge.

LIF (Left Inner Forward) - See Edge.

Lift - A pairs movement in which a partner is assisted aloft.

Line of Travel - Same Direction of Travel.

Link Step - Step used to connect items of a free skating/pairs program.

LOB (Left Outer Back) - See Edge.

Lobe - A curved portion of a pattern beginning and ending at the baseline. See Baseline.

LOF (Left Outer Forward) - See Edge.

Long Axis - See Axis

Loop - (Figures)

a. An edge that spirals in, half circles around, and spirals out to cross itself.

b. A consecutive pair of matched spirals centering on the long axis of a circle.

c. The loop should be egg shaped, not a round circle.

d. The shape of the loop on the crown is the most important.

e. Loops should be executed on a steady radius with at least three wheels in contact with the skating surface.

(Free Skating)

a. In footwork, an edge that spirals in, half circles around, and spirals out to cross itself.

c. A Full Turn Jump starting and landing on the same edge (no toe-plant on the take-off), with rotation in the direction of the edge.

Loop Step - See Euler.

Low Wrap - The body position during the flight of a jump in which the legs and feet are crossed below the knees.

Lunging - An incorrect movement wherein the upper part of the body is thrust forward in an effort to increase momentum.

Lutz - A Full Turn Jump from a LOB take-off with a right (r) toe-plant, counterclockwise rotation, to a ROB landing (no toe-plant on the landing). Can also be done from a ROB take-off with a left (l) toe-plant, clockwise rotation, and a LOB landing.

Manner of Performance - The way or style in which a skater executes the movements of a free skating/pairs routine. See Artistic Impression.

Mapes - A Full Turn Jump from a ROB take-off with a left (l) toe-plant, counterclockwise rotation, to a ROB landing (no toe-plant on the landing). Can also be done from a LOB take-off with a right (r) toe-plant, clockwise rotation, and a LOB landing.

Mark - The total of the grades given by the judges to a skater. Same as score.

Maximum Grade - The highest grade or mark a skater may receive from any one judge.

Maximum Time - See Timing.

Mazurka - A jump variation in which there is a scissoring action with the legs extended downward and straight, with the feet crossed below the knees.

Meet - A competition where more than one contest is scheduled to be conducted.

Minimum Grade - The lowest grade or mark a skater may receive from any one judge.

Minimum Time - See Timing.

Mohawk - A two-foot turn from a forward edge to a similar backward edge or vice versa.

- a. **Closed** - A Mohawk with the free leg in front of the body after the turn. In this type of turn the free foot, upon becoming employed, progresses past the tracing foot. Turns of this type are referred to as progressive type Mohawks. The final closed free hip position gives this Mohawk its name.
- b. **Open** - (American Dance) A Mohawk with the free leg behind the body after the turn. In the forward to backward variety the turn is executed heel to heel. In the backward to forward variety the turn is executed from behind the heel, with the free leg trailing after the turn with the leg moving into open position. Turns of this type are referred to as Chasse' type Mohawks.
- c. **Open** (International Dance) - A Mohawk in which the free foot, during the skating of the forward edge is turned open, then brought to the floor so that it strikes on the inner edge side of the skating foot. The free foot, as it becomes the skating foot, maintains a continuous motion and sweeps the skating foot off the floor and this latter foot maintains an open hip position as it leaves the floor.

d. **Swing Mohawk** - A Mohawk in which the free leg is swung forward past the skating foot and is brought back

close beside the skating foot before stepping down. It may be either an open or a closed swing mohawk depending on where the new skating foot takes the floor and the position (open or closed) of the new free hip.

e. **Dropped** - A Mohawk, either open or closed, after which the second or turn edge is not to be held longer than one beat.

f. **Held** - A Mohawk, either open or closed, the second or turn stroke of which is held longer than one beat of music.

Mohawk Jump - A Two Foot, Half Turn Jump from a forward edge to a similar backward edge or vice versa. Can be performed with either counterclockwise or clockwise rotation in the air.

Momentum - The force of motion acquired by a moving skater as a result of the continuing motion.

Musical Cut - The blending of different pieces of music together.

Non-interpretive Routine - A composition of skating movements which bear no particular relationship to the music used. A routine in which the relationship between movement and music is not recognizable.

Novelty Move - A new or unusual movement or item. See also Quirk.

OB (Outer Back) - The curvature or slide of a backward tracing skate in the direction of the outside of the foot. Also called a Back Outside.

OF (Outer Forward) - The curvature or slide of a forward tracing skate in the direction of the outside of the foot. Also called a Forward Outside.

Off Beat - See Beat.

Official - Bearing approval or authority. Any person commissioned to administer, execute or apply rules and regulations.

- a. Contest - A contest that is part of or leads to or toward the United States Championships.
- b. Rule - A published regulation limiting, controlling, or affecting the entry, participation, conduct, or procedure of a contest, membership, or associate membership.
- c. Ruling - An interpretation or directive by an authorized official or official body made in accordance with published rules.

One Foot Eight - See Paragraph Figure.

One Foot Turn - See Turn.

Open -

- a. The free leg behind the body. A position of the body in which the free hip, leg, knee, and foot are rotated outward.
- b. Competition - Not requiring qualification from a prior contest of lower rank.

Opening Steps - Preliminary edges or flats used to gain or build momentum for the execution of the required edges or flats of a dance.

Optional - Permitted but not required. Subject to choice.

Extended in Dance as follows:

- a. Hold - Selective or discretionary use of hand contact, but with required body position.
- b. Pattern - Arrangement of lobes and/or steps of a dance subject to the skater's choice within the limits prescribed for each specific case.
- c. Opening - Preliminary steps permitting skater's choice of edge or edges within prescribed musical limits.

Ordinal - A number indicating an individual judge's placement of a contestant or contestant team.

Out-of-the-Ordinary - Not regular or customary. Distinctive characteristics not commonly experienced. Unusual style or method.

Outer (abr. O) - A curve wherein the outside of the foot (small toe side) is toward the center of the curve being skated. Also called an Outside Edge.

Outside Edge (O) - A curve wherein the outside of the foot (small toe side) is toward the center of the curve being skated.

Overhead Lift - In pairs, a lift in which the woman is held aloft (above the man's head) by using one or both arms extended above his head in a locked position.

Over Rotation - The excess rotation of the body during the landing of a jump due primarily to the lack of halting or decreasing the rotational momentum before or upon landing.

Pace - The rate of movement of the employed skate and body around a figure.

Pairs Skating - A free skating event in which a team consisting of a man and a woman performs a series of spins, lifts, jumps and connecting footwork in unison with a musical selection.

Paragraph Figure - A figure using two circles which requires the completion of both circles on each take-off. May or may not involve turns.

Parallel -

- a. Position - Relationship of partners wherein hips and shoulders are parallel to each other.
- b. Take-Off - Both feet directly alongside each other and on the same arc at the instant of weight transfer.

Pat Lowe - A Full Turn Jump performed from a RIB take-off, counterclockwise rotation, to a LIB landing (no toe-stop assist on take-off or landing). Can also be done from a LIB take-off, clockwise rotation, to a RIB landing.

Pattern - The course in which a skater/team travels during a free skating/pairs routine. The prescribed relationship of the steps of a dance to a dance baseline.

- a. Border - Steps of a dance having a prescribed relationship to a baseline but without a prescribed location on the floor.
- b. Set - Steps of a dance having a prescribed relationship to a baseline as above and with certain steps required to be executed at the corners of the rink.

Phrase - A short musical expression or group of measures. The number of measures to each phrase varies with the type of music.

Pisces - A jump variation in which the skater performs a partial backbend in the air with the legs and arms rounded backward. Also called an Arch Back Jump.

Pivot -

- a. A rotation of the body around one side, sometimes with the use of the toe-stop of the employed skate.
- b. (Figures) - A movement during the change of feet at circle intersections; to facilitate the thrust required for sufficient momentum, and still allow the required tight closure of the circle. The trailing wheels of the thrusting skate hold the weight while the skate holds the line into the strike zone. The leading wheels slide until the skate is in a position not quite parallel to the long axis, then stopping the slide, sharply, but not violently, thrusts from the inside of the skate. A pivot becomes a hitching error if it does not occur simultaneous to the thrust onto the striking foot.

Pivot Spin - See Spin.

Placement -

- a. The rank achieved by a contestant or contestant team.
- b. The location of turns and take-offs of a given figure.

Placed Step - Any step which takes the floor without a gliding motion.

Planing - A system of body inclination employing horizontal and parallel alignment of the head, shoulders, and hips.

Point - Extension of the toes of the free foot away from the body.

Position -

- a. Body - The relation of members of the body to the torso.
- b. Team - The relation of partners to each other.
- c. Parallel AND Position - Immediately alongside and parallel to the tracing skate.
- d. Angular AND Position - Immediately alongside and angular to the tracing skate.

Posture - Body position used by a skater. Position which will create a baseline through the body.

Posture Baseline - An imaginary line from the center of the skating foot through the hipline and shoulderline.

Primary Footwork - See Footwork.

Primary Movement - An edge or combination of edges not involving a turn.

Principal Part of the Figure - Take-offs, turns, and changes of edge.

Print -

- a. The trace left by the employed skate.
- b. The inscribed circles for Figure Skating.

Program - The presentation by a skater of an organized system of skating movements, including jumps, spins, and footwork, which are blended in harmony with a musical recording. Also known as a routine.

Progressive - A step which moves ahead of the old tracing foot in the direction of travel., thus bringing the new free foot off the floor trailing the new skating foot. (International Dance) It should be noted that the striking foot is not crossed at the point of strike, yet the resulting free leg may cross the trace as it creates the impetus of the stroke.

- a. Crossed - A progressive in which the new tracing foot crosses the old.
- b. In Line - A progressive for which the new tracing foot steps in line with the old.

Progressive Running Steps - A series of progressive steps executed on successive beats of music, not involving cross steps, chasses or changes of direction.

Progression - Movement of a skater or skates on the surface from one location to another in a continuous manner.

Pulled - A take-off or landing which creates a new arc.

Pumping - The incorrect use of hitching and/or body movements designed to gain momentum in a spin.

Pure Edge - An edge without variation in the degree of curvature.

Quadruple Jump - See Jump.

Qualification - The act of meeting the requirements for entry into a contest. The act of advancing from one event to the next in a contest.

Qualify - To meet the requirements for participation in any category in a function of USARS.

Qualifying Placement -

- a. A place in an event which is high enough to permit advancement to the next event of the same contest.
- b. Placing in any contest in a position which permits advancement to the same contest in the next higher ranking championship.

Quirk - Any novelty or out-of-the-ordinary move in any content item (jumps, spins, and footwork).

Raised Chasse' - See Chasse'.

Recording (Music) - A musical composition reduced to some medium for reproduction over a sound system.

Referee - A commissioned official appointed by the director of a contest to discharge the duties as required by rule and prescribed for contests to be skated.

Regular Roll - See Roll.

Requirement -

- a. An individual dance or figure which the skater must execute or perform in a contest.
- b. Any rule or regulation which must be met by a member or associate member for any function of the respective organization.

Revolution - A complete circle (360 degrees) created by the progressive motion of a body around a center or axis.

Rhythm-

- a. Music - A pattern of strong, weak, and off beats which give a type of music its own individual character.
- b. Skating - The movement of the skater's body in harmony with the music, or in harmonious relation with the movement being skated.

RIB (Right Inner Back) - See Edge.

RIF (Right Inner Forward) - See Edge.

Rise - The raising of the body by action of the tracing knee and ankle.

Rise and Fall - An interpretive raising and lowering of the body to impart rhythm and flow to a dance or figure.

ROB (Right Outer Back) - See Edge.

Rock Back - The transference of body weight from the leading skate to the trailing skate without a change of speed.

Rocker (Rk) - A one-foot turn from a forward edge to a similar backward edge, or vice versa, with the rotation continuous with the initial edge and with the cusp inside the original circle.

Rockover - A preparatory body weight shift from one side of the skate to the other, thus changing the edge of the employed skate. Permitting a parallel relationship of the skates at the point of take-off; necessary when moving from an outside edge on one foot to a similar edge on the other foot. A preparatory change of lean to permit a graceful transition from one lobe or circle to the next lobe or circle.

ROF (Right Outer Forward) - See Edge.

Roll - A simple long or short forward or backward outside edge which is in the form of a lobe with the curve in the opposite direction to the preceding edge or lobe. A rolling movement is thus achieved which gives the step its name.

- a. Regular - A natural movement of the skates and body from edge to similar edge.
- b. Cross - A step from one edge to a similar edge with the free leg moved into the direction of travel across the employed leg before the step.
- c. Swing Roll - A roll held for several beats of music during which the free leg swings past the skating foot before returning to the floor at the "and" position.
- d. The constant, unimpeded flow of the employed skate.

Rotate - The act of turning in a circular motion around an axis which runs lengthwise through the center of the body. To turn in a jump.

Rotated - The completion of turning in a circular motion around a an axis which runs lengthwise through the center of the body. The completed number of turns in a jump.

Rotation - A circular motion of the torso in a horizontal plane. A movement of the torso around the posture baseline.

(Dance) -

- a. Concentric - Rotation of partners at the same time around the same team posture baseline. Rotation of partners at the same time on the same arc.
- b. Non-concentric - Rotation of one partner while the other continues in the initial direction. Rotation of both partners at the time when each member of the team turns on a diverging arc.

Routine - See Program.

Serpentine Eight Figure - A figure employing three circles, the first half circle executed from a take-off in the middle circle, followed by another take-off and skating the full circle. One full repetition consists of a strike-off, half circle, take-off, full circle, take-off, half circle, take-off, full circle.

Serpentine Figure - A figure employing three circles, one and one-half circles being executed on each take-off with a change of edge after the first half circle. This may or may not involve turns.

Shoot-the-Duck Tuck - See Tuck.

Short Axis - see Axis.

Shoulders - The entry and exit arcs of a one foot turn or loop.

Showmanship - The ability of a skater to present a free skating performance in a favorable and entertaining manner.

Side Pressure - A primary source of momentum employing pressure against the side of the skate, which is becoming unemployed. The term "Side Push" often is used to mean Side Pressure.

Single Jump - See Jump.

Salchow - A Full Turn Jump from a LIB take-off, counterclockwise rotation, to a ROB landing (no toe-stop assist on take-off or landing). Can also be done from a RIB take-off, clockwise rotation, to a LOB landing.

Sanctioned - Explicit written permission, authorization, confirmation, or recognition of any action by a member or associate member of an organization by the National Governing Body of that organization.

School Figure - Compulsory Figures, see Figure.

Scissor - The act of moving the legs in opposite directions then returning them to the original position.

Score - The total of grades given by an individual judge to a skater or team for the requirements of an event of a contest. Same as Mark.

Scoring -

- a. The act of recording and tabulating the marks of the judges in a contest or event of a contest and determining the results of such contest or event.
- b. The assigning by the judge of individual grades to the various contestants or contestant teams in an event of a contest.

Secondary Footwork - See Footwork.

Secondary Movement - A combination of edges involving a two-foot turn.

Sequence - A related series of steps or turns.

Set In - The pattern formed by the entrance and exit shoulders of a loop figure.

Set-Up Jump - See Jump.

Shadow Skating - In pairs, skating movements done simultaneously by partners without contact.

Shoot-the-Duck - A forward or backward movement on any edge or flat with the body bent in sitting position with one leg extended out in front of the body.

Singles - Free skating performed by individuals.

Sit Spin - See Spin.

Size - The official dimension of circles measured by diameter, inscribed on the skating surface for use in skating of figures. Official sizes permitted are: Standard competition figure 6 meters; Loop Figures 2.4 meters.

Skating Knee - See Employed Knee.

Skating Order - The sequence in which contestants are to perform the required parts of a contest.

Skating Surface - The area designated for a skating performance with boundaries on all sides. Also called floor.

Slide - A step where the free foot (4 wheels) is kept on the surface and moved to a leading position and the employed foot remains directly beneath the body.

Slip Step - A progressive with the leg held for two beats. The free leg crosses the trace behind the skating foot.

Spin - A series of continuous revolutions around an axis that passes through a portion of the body. For full credit as an item in a free skating/pairs program, each position of a spin must be held at least three revolutions, the entrances and exits not being counted.

1. Travel Spin - A spin in which the axis moves.
2. Centered Spin - A spin in which the axis is stationary.
 - a. Circle Spin - A spin in which no wheels pivot and the tracing skate creates a small circle no more than one skate length radius around the center on which it revolves.
 - b. Pivot Spin - A spin in which one wheel pivots while the others slide or roll around it.
3. Two Foot Spin (or Two Toe Spin) - A spin requiring both feet for its execution. A two-toe spin uses the front wheels only on both skates.
 - a. Heel-and-Toe - A combination of an IB on one skate and an IF on the other skate with the front wheels of the IF edge and the rear wheels of the IB edge sliding.
 - b. Crossed-Foot - Executed on two outside edges, one forward and one backward, with the heels and knees turned out and the legs crossed below the knees.
4. One Foot Spin - A spin executed on one skate.
 - a. Upright - a spin in which the body remains in a standing position.
 - b. Sit - a spin in which the seat is lower than the employed knee.
 - c. Camel - a spin wherein the body is in a continuous arched line from head through free foot while remaining no less than parallel to the floor.
5. Combination Spin - A spin in which the position is changed or the spinning edge is changed, or both, without involving a change of feet.
6. Change-Foot Spin - A spin, which involves a change of feet.
7. Jump Spin - A spin with a jump as the means of entry.
8. Spin-Jump-Change-Foot - A spin that involves a jump and a change of feet between the component spins.
9. Spin Variation - Any spin that is out-of-the-ordinary in both body positions and unusual methods of spinning.

Spin Variation - See Spin.

Spiral -

- a. A curve which constantly approaches or recedes from the center around which it revolves.
- b. A body position with the body inclined forward and the free leg held parallel to the skating surface. See Arabesque.

Split -

- (a) (Dance) - A two foot step where one foot (4 wheels) is kept on the surface and moved to a leading position and the other foot (4 wheels) is moved to a trailing position.
- (b) (Free Skating) - A leap or jump variation in which the legs are extended away from the body as far as possible.

- a. Full Split - Hips across the leg line with one leg extended in front and the other in back.
 - b. Straddle Split - Hips in-line with the legs, both legs extended down and outward to the side of the body.
 - c. Russian Split - A Full Split with the legs parallel to the seat and toes pointed upward. Legs are generally in a wide "V" shape in front of the body with arms extended toward the feet.
 - d. Stag Split - Similar to a Scissor Split, except the front leg is bent with the foot brought up under the body.
- Spotting** - In spinning, the centered axis being stationary in one spot on the skating surface.

Spread Eagle - A movement in which the feet are split apart to the side of the body with the toes pointed outward in opposite directions.

Stag - See Split.

Stance - A stationary position preceding a start.

Start - The beginning of a movement from a stationary position.

Starting Steps - See opening steps.

Statue-of-Liberty - A jump variation in which one hand extends high over the head while the other hand is held tightly across the midsection of the body and bent at the elbow.

Steering - An unnatural movement or positioning of any part of the body to control the direction or path of the employed skate.

Step - The transference of body weight from one foot to the other.

Step Jump - See Jump.

Stepping Out - An expression for a common error of jumping in which the skater cannot hold balance and/or body control on the landing of a jump and must step to the other foot to regain balance.

Steward - A competition official with direct charge over the progression of a portion of an event.

- a. Record Steward - An official charged with the supervision of play of the recordings used in a free skating event.
- b. Competitor's Steward - An official charged with the undelayed succession of competitors in their proper order.

Stiff - Rigid, inflexible, and not easily bent. Impeded flow. Lacking in ease or grace.

Straightaway -

- a. The area on the sides of the skating surface, parallel to the barrier, which is the longest linear dimension of the floor. The area of a skating surface of greatest length.
- b. That part of a dance that is to be skated only in the area of a skating surface of greatest length.

Strike-Off - The starting or initial stroke of a figure.

Striking Foot - The newly employed skating foot.

Strike Zone - The area along the short axis, one skate length on either side of the long axis where a strike off is correctly performed.

Stroke - A step executed so as to impart momentum.

a. Placed Stroke - A stroke for which the new tracing foot is placed on the skating surface without a gliding motion.

b. Full Stroke - A stroke employing a gliding motion of the new tracing skate.

Stroking - See Cross Over.

Strong Beat - See Beat.

Style - The individual expression of the skater or team. In Free Skating/Pairs, expression without requirement.

Sub Curve - An unintentional deviation from the arc required.

Sum - The total of the individual scores given by a single judge for a single contestant or contestant team.

Superimposition - Successive tracings upon an original tracing.

Swing - A controlled movement of the free leg from trailing to leading position or vice versa, with both positions matched as to height from the floor, relation to the body, and relation to the employed skate.

Swing Rocker or Counter - A type of rocker or counter turn in which the free leg is swung forward past the skating foot before the turn is executed. After the turn, the free leg is either swung forward past the skating foot and held over the tracing line or is swung behind the skating foot and held over the tracing line.

Take Off - The beginning of a new edge or flat from another edge or flat.

a. Two Foot - An incorrect movement during which the skater rides both skates for a noticeable distance.

b. Toe Stop - An incorrect movement where the toe stop is used to help impart momentum.

c. Clean - A correct take off. A take off employing a smooth transition from one foot to the other without placing, hitching, jumping, or any other stiff, unnatural movement.

d. (Free Skating) - The first component part of a jump in which preparation and execution of carrying the entire body and skates off the skating surface is accomplished, after which the body is airborne.

d. Strike-off – initial start.

f. In-line - A take-off where the new tracing foot is placed in line with the old tracing foot, in a continuous motion.

g. Pocketed - A take-off where the heel is placed at the instep on the forward takeoff and the toe is placed at the instep on the backward take-off in a continuous motion.

h. Pivot - On all take-offs the pivot must occur before the placement of the new skating foot. Even though the foot pivots, the motion is continuous and uninterrupted.

i. A take off can be pocketed or in-line and receive the same credit as long as it has been done correctly, smoothly, and done within the boundaries of the strike zone.

Take-Off Edge - The edge executed by the employed skate at the point of departure from the skating surface during the take-off of any jump.

Tandem - See C Position.

Technical Merit - In competition, the score given by a judge for the level of difficulty of the jumps, spins, and footwork performed during a free skating/pairs program. See Content of Program.

Tempo - The pace and speed of a musical composition. The number of beats per minute.

Three (3) - A one-foot turn from a forward edge to an opposite backward edge or vice versa, with the rotation in the direction of the initial edge, and with the cusp inside the circle.

(Dance)

a. Dropped - A three turn, which is executed on the last beat of a stroke. A three turn where the concluding edge is held for no more than one beat of music.

b. Held - A three turn, the concluding edge of which is held for more than one beat of music.

Thrusting Foot - The pushing foot (the about to be free foot).

Time - The time indicated by the stop watches and recording by the appropriate official.

Timer - An official whose duty is to determine the elapsed time of any event or part of an event in accordance with the established rules for the contest in which he serves.

Timing - The relationship between the accent of the music and the steps skated.

Timing for Free Skating - The length of time a free skating/pairs program is performed. Official timing of a routine begins when the skater moves any part of his or her body.

a. Minimum Time - The official designated time a skater must remain within the boundaries of the floor during a free skating/pairs program to avoid disqualification.

b. Maximum Time - The official designated time limit a skater may be judged during a free skating/pairs program. Official timing of a routine ends when Maximum Time is reached.

Timing for Skate Dancing - Timing for Skate Dancing is the harmonious relationship between the "Team" movements in executing the correct fundamentals of skating and the specified requirements of the dance to support the musical accompaniment. As a primary fundamental, harmonious relationship would require that the proper steps

are skated on the proper count and are sustained for the proper number of beats.

Toe-Plant - The correct use of the toe-stop of the unemployed skate to assist the take-off and/or landing of a jump as provided in the description and requirements of the jump executed. Also called a Toe-Point.

Toe Point - A required contact with the skating surface of the toe roller or rollers of the unemployed skate.

a. Front Toe Point (FTP) - A toe point with the outside front roller in front of the body.

b. Back Toe Point (BTP) - A toe point with the inside front roller behind the body.

Toe-Stop - The device securely attached to the skate at the toes (in front of the forward rollers) made of rubber or a similar material.

Toe-Stop Assist - The incorrect use of the toe-stop of the employed skate to assist the take-off and/or landing of a jump according to the description and requirements of the jump executed.

Toe-Stop Spin - A pivot spin variation executed on the front rollers and the toe-stop of the employed skate.

Toe Walley - A Full Turn Jump from a RIB take-off with a left (l) toe-plant, counterclockwise rotation, to a ROB landing (no toe-plant on the landing). Can also be done from a LIB take-off with a right (r) toe-plant, clockwise rotation, and a LOB landing.

Torque - Opposing rotation of the shoulders and hips around the body axis.

Tracing or Trace - The real or imaginary mark showing the path of the employed skate.

Employed. In use.

a. Tracing Foot - The employed foot.

b. Tracing Knee - The knee of the employed foot.

c. Tracing Skate - The skate on the surface. The employed skate.

Tracking - The superimposition of tracings of partners.

Trailing - Following the direction previously traced.

Transition - A change from one edge to another; a change from one circle to another; a take off.

Travel - One of the three dimensions of a jump designated by the distance of the flight of the jump on the skating surface. Refers to the amount of distance between take-off and landing. See also Spin (Travel Spin).

Travel Spin - See Spin.

Trick - See Novelty Move.

Triple Jump - See Jump.

Triple Repetition - Three consecutive executions of a round of a figure.

Tuck -

1. (Dance) - A movement wherein the knee of the free leg is bent and brought close to the employed knee before being extended to the rear. The free foot does not touch the floor during this movement.

2. (Free Skating) - A jump variation in which both legs are held tightly together and bent at the knees and hips so as to bring the feet up under the body.

a. Cannonball Tuck - Both legs tucked under the body with both arms wrapped around the legs.

b. Shoot-the-Duck Tuck - One leg extended forward similar to the front part of a Full Split, while the other leg is tucked under the body.

Turn -

1. (Dance) - A change of direction of skate or skates.

a. One foot turn - A turn without the change of feet. See Bracket, Counter, Rocker, and Three.

b. Two foot turn - A turn produced with both feet by changing from one foot to the other. See Choctaw and Mohawk.

c. Open - A turn with the free leg behind the body after the turn. See Choctaw and Mohawk. A chasse' type turn.

d. Closed - A turn with the free leg in front of the body after the turn. See Choctaw and Mohawk. A progressive type turn.

e. Held - A turn the concluding edge of which is held longer than one beat of music. See Choctaw, Mohawk, and Three.

f. Dropped - A turn the concluding edge is held not longer than one beat of music. See Choctaw, Mohawk, and Three.

g. Pulled - An incorrect movement wherein the skater uses some part of his body to increase the momentum of the tracing skate during the execution of a one foot turn.

h. Jumped - An incorrect movement during which more than one wheel of the employed skate leaves the floor during the execution of a one foot turn.

i. Kicked - An incorrect movement during which the free leg is kicked past the skating leg before or during the turn.

2. (Free Skating) - In jumping, a 360 degree rotation of the body while in the air.

a. Half Turn - 180 degree rotation of the body in the air.

b. Full Turn (Single Turn) - 360 degree rotation of the body in the air. One turn.

c. Double Turn - 720 degree rotation of the body in the air. Two turns.

d. Triple Turn - 1080 degree rotation of the body in the air. Three turns.

e. Quadruple Turn - 1440 degree rotation of the body in the air. Four turns.

Turning Open - A common error in jumping describing the action of stepping forward onto the toe-stop into the direction of travel during the take-off of a jump. Most commonly done on a Mapes or Toe Walley.

Twistover Camel - A spin variation done in the Camel position executed by the free side hip and upper body closing into and under the employed side.

Twizzle - A turn of one revolution executed in less than one beat of music. The approach to the turn is a LOF edge during which the free leg is advanced forward and the right shoulder pressed back. To execute the turn, the free foot is brought to the heel of the tracing foot. Then a very short counter turn followed by a BO half-three turn is executed. The right foot should be turned outward a right angles to help create a semi-spin and to be in position for a right angle push to the ROF when the turn has been completed

Unity - The harmonious performance of identical or compatible skating movements by partners.

Upright - See Spin.

Variety Move - A movement in a free skating/pairs program that is graceful, out-of-the-ordinary, and made to show originality.

Violent - An action marked by extreme force or sudden, intense, and uncontrolled movement.

Walley - A Full Turn Jump from a RIB take-off, counterclockwise rotation, to a ROB landing (no toe-stop assist on take-off or landing). Can also be done from a LIB take-off, clockwise rotation, to a LOB landing.

Waltz Jump - A Half Turn Jump performed from a LOF take-off, counterclockwise rotation, to a ROB landing (no toe-stop assist on take-off or landing). Can also be done from a ROF take-off, clockwise rotation, to a LOB landing.

Weak Beat - See Beat.

Wobble - A tracing error in which there is a constant shifting of weight or pressure from one side of the employed skate to the other.

ABBREVIATIONS

3	Three Turn	I	Inside Edge
B	Backward	ILC	In Line Chasse'
Bar	Barrier	ILDC	In Line Dropped Chasse'
Br	Bracket	ILP	In Line Progressive
BTP	Back Toe Point	L	Left Foot
C-E	Change of Edge	Moh	Mohawk
C	Center	O	Outside Edge
Cho	Choctaw	R	Right Foot
Cw	Clockwise	RC	Raised Chasse'
CCw	Counterclockwise	Rk	Rocker
Co	Counter	SDC	Swing Dropped Chasse'
DC	Dropped Chasse'	-S->	Swing of Free Leg
F	Forward	X-Roll	Cross Roll
Fl	Flat	XB	Crossed in Back
FTP	Front Toe Point	XF	Crossed in Front

FIGURE SKATING

ARFG-A ANALYSIS OF FIGURES

I. Axis

- Figures are performed upon circles known to the average skater as "figure eights." The circles are grouped in twos and threes in line or on a common axis. This is called the long axis, or main axis. It divides the figure lengthwise. On the diagram below, it is marked as line "A."
- Transverse axes occur at right angles to the long axis at the points where adjacent circles touch. These axes lines divide the figures into equal halves, or in the case of Serpentine, equal thirds. In the diagrams the transverse axis lines are marked "B."
- It should be clearly noted that all axis lines are intended for illustration only, and must not be marked on the

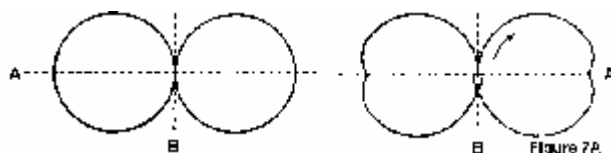

skating floor.

Above is illustrated the eight figure. Note how the figure is divided by the long axis and transverse axis. For example, study Figure 7A, which is a Three, ROF-LOF. The Threes would be turned at the long axis on each circle. The take-off would be carefully made at the intersection of the axes and aimed along the transverse axis.

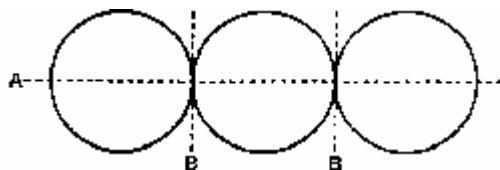

Note that the two transverse axes into three equal parts or circles divide the Serpentine Figure.

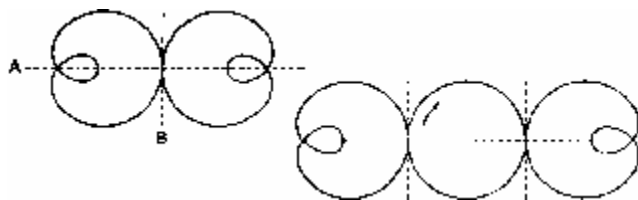

The above diagram (left) illustrates a Loop Figure. For certain figures, the loops are also inscribed upon Serpentine (right). The loops are the only figure which is marked on the skating floor and which is traced directly to the marked line. All other "turn figures" are skated upon the circles with the skater determining the exact location of each "turn."

2. Principal Parts Of Figures

In assigning a mark, the judge shall give equal scoring value to: a) the principal parts of the figure, b) form and movement. The principal parts of the figure by definition are take-offs (strike-offs), changes of edge, tracing and turns.

3. Starting Figures

All figures must be skated from the standing start. Starts must be made with a single push from a stationary position; without lunging, buckling and double-leans. The starting edge must be a pure edge, without flats or sub-curves. Starts must be made from the "flat" of the employed skate only. The judges will penalize starts made from the toe stop. The skater has the option to skate in either direction, providing the start is on the proper

foot and edge. The thrusting foot is to be placed no more than one skate length from the long axis. The thrusting foot cannot move toward the long axis until the striking foot moves into the direction of the required initial edge. The thrusting foot must leave the floor before crossing the long axis.

4. Interruption of a Figure

- a. A skater who slips or falls on the initial strike-off may elect to restart once without penalty, provided the skater's decision to restart is made during the first one-third of the first circle of the figure. In a case where, for any reason, the skater through his own fault falls or stops a figure, the referee shall instruct him to restart at a point just prior to the interruption. This distance shall be left to the discretion of the referee.
- b. In cases of outside interference when the skater does not stop, the referee may allow the skater to finish the figure and then give him the option of reskating or letting the figure stand. If the skater chooses to reskate, the referee shall instruct the judges to ignore the prior figure skated and judge the reskated figure anew, without penalty. If the referee inadvertently stops the skater before the proper repetitions have been completed, it shall be considered, as outside interference and the skater shall have the option of reskating the entire figure anew or completing the figure from the point of interruption.

5. Strike Zone

For the incoming or outgoing edge, the skater must go at least as far as point "A" on his employed foot at which time he will slide the employed foot and push onto a new edge at the same time. When stepping onto the new edge, he must place it between points "B" and "C." This is the allowable skate length distance in which a skater must place his skate on a take-off. This holds true for all take-offs, although the skater will take more of the allowable skate length on backward take-offs. Outside take-offs will have a tendency to be late. Inside take-offs will have a tendency to be early.

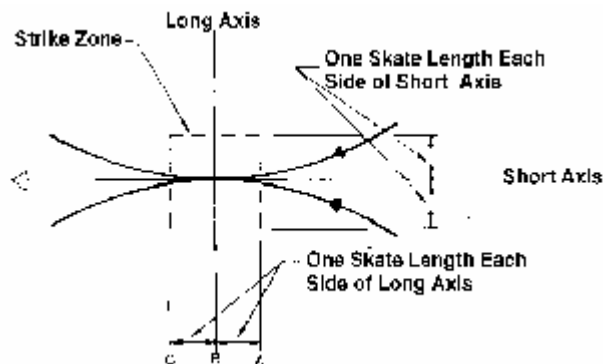

6. Take-Offs

A take-off is the beginning of a new edge while in motion. All take-offs should be a smooth, easy transition from one foot to the other, with a single push from the skate leaving the surface. The thrusting foot should not deviate from the circle until reaching that portion of the strike zone that precedes the long axis. Such deviation, when it occurs, must remain within one skate length either side of the short axis. Any part of the striking skate may take the floor at the long axis. The thrusting foot must leave the floor on or before crossing the long axis. The feet should be reasonably close during the take-off.

A few of the most common errors made on changing feet are double leans, flats, "S" curves, sub-curves and pulls. Outer take-offs have a tendency to be late, inner take-offs have a tendency to be early. The thrusting foot must leave the floor before rolling across the long axis. Backward take-offs are more difficult to stop before touching the long axis. The skate may touch the long axis, as long as both feet are not left on the floor and the thrusting foot dragged past.

a. Outside Forward Take-Off

- (1) The outside forward edge is maintained right up to the strike zone (approximately one skate length from the long axis). A sharp, but true, outside forward curve of departure from the main arc into the circle being skated is followed immediately by a short, quick rockover to the inside from which the thrust is made.
- (2) Any part of the striking skate may take the floor at the axis.
- (3) The thrusting foot pivots, stops and leaves the floor before crossing the long axis.
- (4) The skate stops, but the forward motion continues.
- (5) The take-off should be a quick, precise transition from one foot to the other with a single push from the skate leaving the surface.
- (6) The feet should be reasonably close during the take-off.
- (7) There must be a quick pivot of the old skating foot before the new skating foot takes the floor.

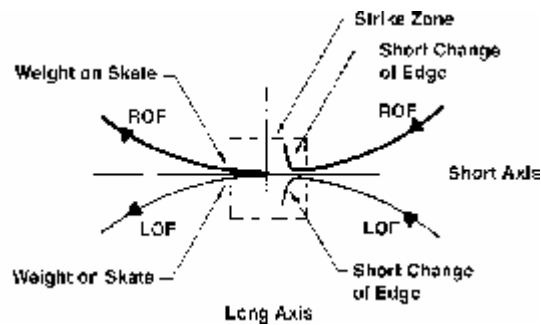

b. Inside Forward Take-Off

- (1) The inside forward edge is maintained right up to the strike zone (approximately one skate length from the long axis), followed immediately by a quick pivot staying on the inside edge from which the thrust to the new inside edge is made.
- (2) The inside forward take-off is different from the outside take-off in that there is no short rockover on the take-off. This take-off must be done inner to inner.
- (3) The inside forward take-off is much harder to close to the strike zone than the OF take-off.
- (4) Any part of the striking skate must take the floor at the axis.
- (5) The take-off should be a quick, precise transition from one foot to the other with a single push from the skate leaving the surface.
- (6) The feet should be close during the take-off.
- (7) There must be a quick pivot of the old skating foot before the new skating foot takes the floor.

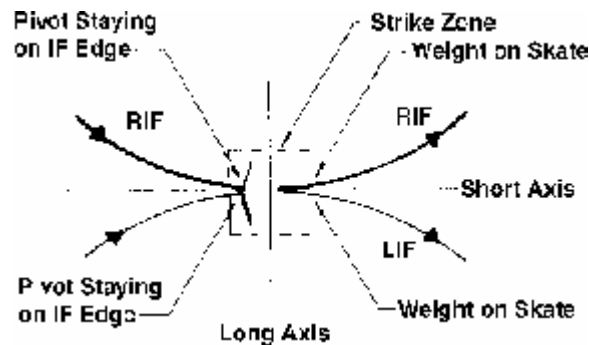

c. Outside Back Take-Off

- (1) The outside backward edge is maintained right up to the strike zone (approximately one skate length from the long axis). A sharp, but true outside back curve is made for the departure from the main arc into the circle being skated and is followed immediately by a short, quick rockover to the inside from which the thrust is made.
- (2) Any part of the striking skate may take the floor at the axis.

- (3) The thrust foot pivots, stops and leaves the floor before crossing the long axis. NOTE: Backward take-offs are difficult to stop before touching the long axis. It is not considered an error to touch the long axis as long as the skater does not keep both feet on the floor and drag the thrusting foot through.
- (4) The thrusting foot should not be dragged across the circle previously traced.
- (5) The skate stops, but the motion continues.
- (6) The take-off should be a quick, precise transition from one foot to the other with a single push from the skate leaving the surface.
- (7) The feet should be reasonably close during the take-off.
- (8) There must be a quick pivot of the old skating foot before the new skating foot takes the floor.

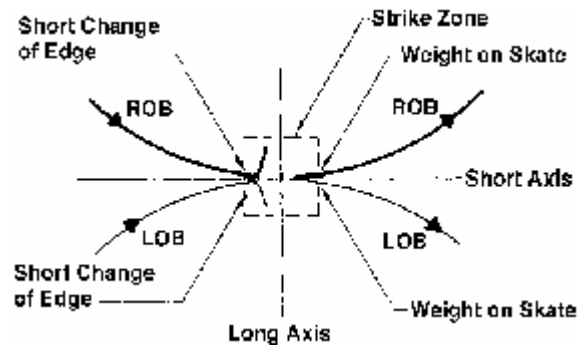

d. Inside Back Take-Off

- (1) The inside backward edge is maintained right up to the strike zone (approximately one skate length from the long axis), followed immediately by a quick pivot staying on the inside edge from which the thrust to the new inside edge is made.
- (2) The inside backward take-off is different from the outside take-off in that there is no short rockover on the take-off. The take-off must be done inner to inner.
- (3) The inside backward take-off is much harder to close to the strike zone than the OB take-off.
- (4) Any part of the striking skate must take the floor at the axis.
- (5) The thrusting foot pivots, stops and leaves the floor before crossing the long axis. NOTE: Backward take-offs are difficult to stop before touching the long axis. It is not considered an error to touch the long axis as long as the skater does not keep both feet on the floor and drag the thrusting foot through.
- (6) There must be a quick pivot of the old skating foot before the new skating foot takes the floor

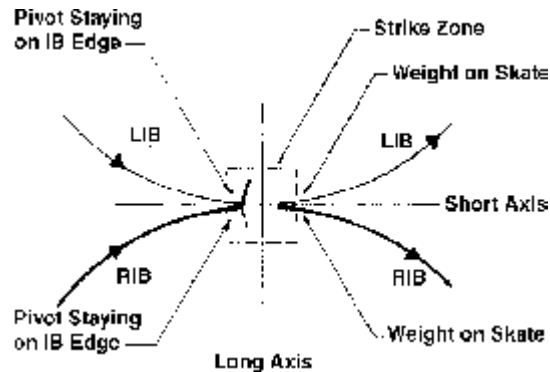

e. Important points on all take-offs:

- (1) The edges on all take-offs should be held to one skate length before the axis and the new employed foot should assume the weight of the body no later than one skate length past the long axis (the strike zone on all take-offs).
- (2) The pushing skate should leave the floor before rolling through the long axis.
 - (a) The outer take-offs have a tendency to be late.
 - (b) The inner take-offs have a tendency to be early.
 - (c) The slide on the inner take-offs must be done from the inside of the foot (inner to inner).

- (d) The backward take-offs are more difficult to stop before touching the long axis. The skate may touch the long axis as long as both feet are not left on the floor and the pushing foot dragged through. The pushing foot may not recross the circle previously traced.
- (3) Only one thrust in a figure is made from rest, and this should be made with good edge quality (absence of flats or sub-curves). The other thrusts occur when the skater has momentum and may differ slightly from the original thrust from rest. However, this difference should be avoided if possible.
- (4) Take-offs should be quick, precise changes from one foot to the other with a single push from the skate leaving the surface. NOTE: This is not to be construed that the take-offs are to be done violently. Everything violent, stiff or angular is to be avoided.
- (5) All take-offs are skated with complete control over the skate at all times. This means that an even roll or flow is preferred on take-offs to skate a figure of consistent edge quality. NOTE: The pace of the take-offs once chosen should not move with a jerky forward-backward motion.

7. CHANGES OF EDGE

Although there is no rule controlling the use of the free leg during a change of edge, the change should be done with an easy transition, cutting the long axis and approximately tangent to the short axis. Judges will give less credit for changes of edge improperly executed with "S" curves. When in the form of an eight, the change edge should be placed at the starting point of the first curve, and the second curve should return to the same point so that both circles will be uniform.

8. TURNS

The referee must insure that the skater is properly informed of the figure to be skated. When a skater starts a figure improperly, the referee shall stop the contestant and instruct him to restart correctly. Once the referee starts the skater on the proper foot, into the proper edge, into the proper circle, the referee shall have no further responsibility regarding incorrect turns.

All figure turns must be executed smoothly, without pulling, kicking or jumping; they must be placed in the prescribed location on the circle; every effort shall be made to maintain four wheel contact with the skating surface during the execution of the turn; the entrance and exit shoulders of the cusp of every turn must be accurately skated, with no deviation to a flat or change of edge; the cusps in any given figure shall be of equal size.

9. TRACING

Figures should be skated on the edge of the skate, inside or outside as indicated, without changes of edge or flats except as indicated in the diagrams of the figure. Less credit will be given for prohibited changes of edge than flats that are erroneously executed. The tracing skate should be kept as close as possible to the painted line of the figure. There should be no deviation from the arc being skated, except at the transitions from one foot to the other. The tracing should be a pure edge, with no flats or sub-curves.

10. CONCLUDING FIGURES

Skaters may conclude a figure using the American style (executing a subsequent take-off) or the international style (continuing the roll past the long axis). Either method is equally correct.

11. FORMS OR CARRIAGE

In considering correct carriage, the judges must take into consideration the individual characteristics of the skater.

The body should be erect, without bending at the waist, but also without stiffness. The head should be carried upright and the employed knee should be bent. Correct body axis must be maintained at all times (see diagram). The free foot should be held slightly off the floor, with the toe pointed downward and outward. The free leg should be extended and carried over the tracing an equal distance from the employed skate, whether carried in front or behind, and used to assist the general skating movement.

The arms shall be extended away from the body, with the hands carried approximately waist high and they shall not droop at the wrist. The fingers should be neither spread nor clenched.

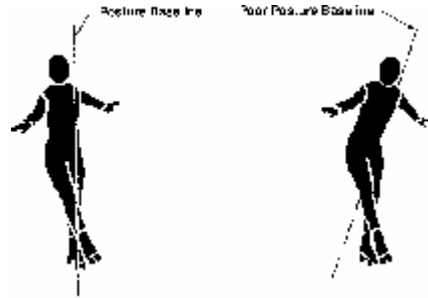

12. EXECUTIONS OR MOVEMENT

All figures should be skated with complete control over the skate at all times. All figure skaters must maintain the flow or roll of the skate in order to execute an accurate figure. This means that the skate may not move with a jerky forward-backward motion (chugging). Figure skating should not be violent, stiff or angular.

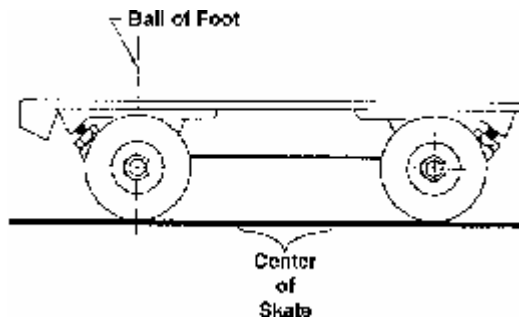

13. SLIPS, FALLS AND INTERFERENCE

If a skater falls or stops while skating a figure, the referee will have the skater start from a point previous to the fall or stop. The judges will resume judging from the point of fall or stop. If the skater is interfered with in any way to cause a fall or stop, the referee will allow the skater to start the figure from the beginning without penalty after whatever rest the referee decides is necessary.

The referee will start the skater on the proper foot, edge and circle. Subsequent falls and incorrect skating of turns must be marked accordingly. No judge or official is permitted to enter any of the circles or loops being skated upon. Any such action will be considered outside interference and the skater will be allowed to start the figure again.

14. TRICKS

There are many tricks to assist a skater in execution of tracing and turns; many of these are listed below as faults. Some other tricks are: Forced edges, cross-pulls, steering, hitching, double pushes, two-foot take-offs, and placing turns purposely off axis in order to match previous turns for super-imposition.

Forced edges are tracings made with the weight outside the circumference of the curve as evidenced by double lean.

Cross-pulls are a primary source of momentum in which the free leg, or another portion of the body, is moved across or at an angle to the tracing, causing the tracing skate to follow. Steering is the unnatural movement or positioning of any part of the body to control the direction or path of the employed skate. Hitching occurs when the tracing skate does not follow the arc to be skated and the skater continually pulls the leading wheels of the skate back to the line.

ARFG-B FIGURE SKATING PRECEPTS

1. In all competitive figure events, judges must consider the following applicable points:
 - a. Start
 - b. Tracing
 - c. Turns/Loops and/or Change of Edge
 - d. Second Turn
 - e. Placement of Turns
 - f. Tracing after/between turns
 - g. Circle Closure
 - h. Subsequent Take-Offs
 - i. Concluding Figure

2. Form must be given the required full consideration throughout the skating of the entire figure.

3. Each figure contains turns, take-offs, etc., of specific difficulty. These factors must be given due consideration in determining the score while still giving full consideration to the other judging points of the figure. The major faults of figure skating and their corresponding point deduction include:
 - a. Putting the free foot on the floor will cause the assigned score to be reduced a minimum of 10 points.
 - b. Falling on a figure will result in the assigned score being reduced a minimum of 20 points.
 - c. Unwarranted rock-over or changes of edge, producing an incorrect turn, shall be penalized according to the degree of the error.
 - d. An incorrect turn, a three turn instead of a bracket, or a rocker instead of a counter, will be assigned a score reduction of a minimum of 20 points.

4. It is the responsibility of the referee to inform the judges of these major faults immediately after the involved skater has finished the figure.

5. Establishing a pure edge, even one that is not on the line, is the most important part of tracing. Tracing, even though on the line, which is effected at the expense of edge quality (skate wobble), shall be penalized. The momentum of the figure is evaluated by the consistency of edge and speed.

ARFG-C FIGURE DESCRIPTIONS AND DIAGRAMS

Official Figure Numbering System

Figure No.	Starting Edges	Description
1.....	ROF-LOF.....	Circle Eight
1A.....	ROIF-LOIF.....	Change Eight
1B.....	LOIF-ROIF.....	Change Eight
2.....	RIF-LIF.....	Circle Eight
2A.....	RIOF-LIOF.....	Change Eight
2B.....	LIOF-RIOF.....	Change Eight
3A.....	ROB-LOB.....	Circle Eight
3B.....	LOB-ROB.....	Circle Eight
4.....	RIB-LIB.....	Circle Eight
5A.....	ROIF-LIOF.....	Serpentine
5B.....	LOIF-RIOF.....	Serpentine
6A.....	ROIB-LIOB.....	Serpentine
6B.....	LOIB-RIOB.....	Serpentine
7A.....	ROF-LOF.....	Threes
7B.....	LOF-ROF.....	Threes
8A.....	ROF-LIB.....	Threes
8B.....	LOF-RIB.....	Threes
9A.....	RIF-LOB.....	Threes

9B	LIF-ROB	Threes
10A	ROF-LOF	Double Threes
10B	LOF-ROF	Double Threes
11A	RIF-LIF	Double Threes
11B	LIF-RIF	Double Threes
12A	ROB-LOB	Double Threes
12B	LOB-ROB	Double Threes
13	RIB-LIB	Double Threes
14A	ROF-LOF	Loop
14B	LOF-ROF	Loop
15A	RIF-LIF	Loop
15B	LIF-RIF	Loop
16A	ROB-LOB	Loop
16B	LOB-ROB	Loop
17A	RIB-LIB	Loop
17B	LIB-RIB	Loop
18A	ROF-LIB	Bracket
18B	LOF-RIB	Bracket
19A	RIF-LOB	Bracket
19B	LIF-ROB	Bracket
20A	ROF-LOB	Rocker
20B	LOF-ROB	Rocker
21A	RIF-LIB	Rocker
21B	LIF-RIB	Rocker
22A	ROF-LOB	Counter
22B	LOF-ROB	Counter
23A	RIF-LIB	Counter
23B	LIF-RIB	Counter
24A	ROIF-LIOF	Paragraph Eight
24B	LOIF-RIOF	Paragraph Eight
25A	ROIB-LIOB	Paragraph Eight
25B	LOIB-RIOB	Paragraph Eight
26A	ROIF-LOIB	Serpentine Threes
26B	LOIF-ROIB	Serpentine Threes
27A	RIOF-LIOB	Serpentine Threes
27B	LIOF-RIOB	Serpentine Threes
28A	ROIF-LIOF	Serpentine Double Threes
28B	LIOF-RIOF	Serpentine Double Threes
29A	ROIB-LIOB	Serpentine Double Threes
29B	LOIB-RIOB	Serpentine Double Threes
30A	ROIF-LIOF	Serpentine Loop
30B	LOIF-RIOF	Serpentine Loop
31A	ROIB-LIOB	Serpentine Loop
31B	LOIB-RIOB	Serpentine Loop
32A	ROIF-LOIB	Serpentine Bracket
32B	LOIF-ROIB	Serpentine Bracket
33A	RIOF-LIOB	Serpentine Bracket
33B	LIOF-RIOB	Serpentine Bracket
34A	ROF-LIF	Paragraph Threes
34B	LOF-RIF	Paragraph Threes
35A	ROB-LIB	Paragraph Threes
35B	LOB-RIB	Paragraph Threes
36A	ROF-LIF	Paragraph Double Threes
36B	LOF-RIF	Paragraph Double Threes
37A	ROB-LIB	Paragraph Double Threes
37B	LOB-RIB	Paragraph Double Threes
38A	ROF-LIF	Paragraph Loop
38B	LOF-RIF	Paragraph Loop
39A	ROB-LIB	Paragraph Loop
39B	LOB-RIB	Paragraph Loop
40A	ROF-LIF	Paragraph Bracket
40B	LOF-RIF	Paragraph Bracket

41A.....	ROB-LIB.....	Paragraph Bracket
41B.....	LOB-RIB.....	Paragraph Bracket
111A.....	ROF-LOF.....	Serpentine Eight
111B.....	LOF-ROF.....	Serpentine Eight
112A.....	RIF-LIF.....	Serpentine Eight
112B.....	LIF-RIF.....	Serpentine Eight
113A.....	ROB-LOB.....	Serpentine Eight
114.....	ROF-LOF.....	Loop Circle Eight
115.....	RIF-LIF.....	Loop Circle Eight
116.....	ROB-LOB.....	Loop Circle Eight
117.....	RIB-LIB.....	Loop Circle Eight
130A.....	ROIF-LIOF.....	Serpentine Loop Circle
130B.....	LOIF-ROIF.....	Serpentine Loop Circle
131A.....	ROIB-LIOB.....	Serpentine Loop Circle
131B.....	LOIB-ROIB.....	Serpentine Loop Circle
138A.....	ROF-LIF.....	Paragraph Loop Circle
138B.....	LOF-RIF.....	Paragraph Loop Circle
139A.....	ROB-LIB.....	Paragraph Loop Circle
139B.....	LOB-RIB.....	Paragraph Loop Circle

I. Geometry of a Figure

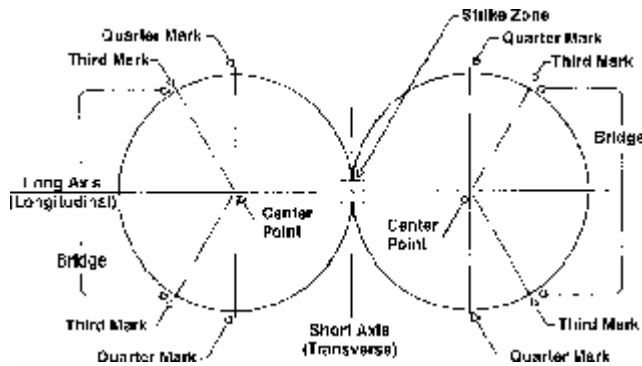

a. Circle Eight

- Figure: 1 ROF-LOF
 2 RIF-LIF
 3A ROB-LOB
 3B LOB-ROB
 4 RIB-LIB

Circle Eight Figures are composed of two circles, which form an eight. Each of these figures begins on the right foot at the intersection of the long and transverse axes, skating a complete circle on each foot. The first and second half of the eight should be of equal size when divided by the transverse axis. The diagrams below show the transition from one foot to the other. The illustration of Figure 1 shows the transition from an outside to an outside edge and the illustration of Figure 4 shows the transition from inside to inside edges.

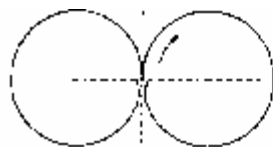

Figure 1 Illustrated

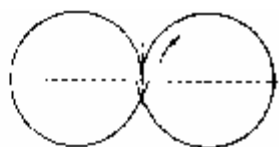

Figure 4 Illustrated

b. Change Eight

- Figure: 1A ROIF-LOIF
1B LOIF-ROIF
2A RIOF-LIOF
2B LIOF-RIOF

Change Eight Figures are composed of two circles, which form the eight. These figures are started, not at the point the two circles meet, but at the long axis at the top or end of either circle. The first half circle is skated with a change of edge occurring at the long axis to skate the second half circle. Changing foot and edge at the other end of the circles and repeating the process using the other foot complete the figure.

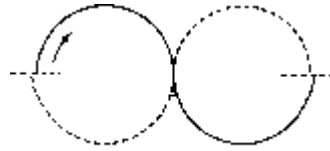

Figure 1A Illustrated

c. Serpentine

- Figure: 5A ROIF-LIOF
5B LOIF-RIOF
6A ROIB-LIOB
6B LOIB-RIOB

Serpentine Figures are composed of three circles. All Serpentine Figures start on the center circle, skating half of the center circle, changing edge at the long axis and skating the whole of the end circle; then repeating the process on the other foot. The change of edge should be made approximately perpendicular to the long axis with an easy transition. Expect less credit for changes of edge improperly executed with "S" curves and for changes of edge executed too early or late or with unduly long flats.

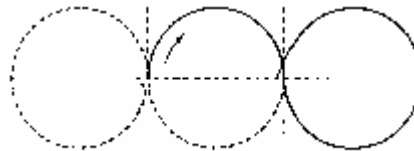
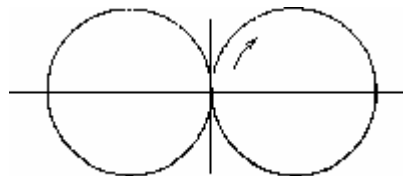

Figure 5A and 6B Illustrated

d. Paragraph Eight (One Foot Eight)

- (One-Foot Eight)
Figure: 24A ROIF-LIOF
24B LOIF-RIOF
25A ROIB-LIOB
25B LOIB-RIOB

Paragraph Eight Figures are composed of two circles, which form an eight. These figures are started at the point of tangency of the two circles at the intersection of the long and short axes. After the initial take-off, the skater will skate both circles on the same foot involving a change of edge until returning to the intersection of the axes, whereby there will be a change of foot and two circles will be skated on the other skate. Four circles skated will complete one time through the figure.



Paragraph Eight Illustrated

e. Threes

- Figure** 7A ROF-LOF
Eight 7B LOF-ROF

Threes: 8A ROF-LIB
 8B LOF-RIB
 9A RIF-LOB
 9B LIF-ROB

Serpentine Threes

Figure: 26A ROIF-LOIB
 26B LOIF-ROIB
 27A RIOF-LIOB
 27B LIOF-RIOB

Paragraph Threes

Figure: 34A ROF-LIF
 34B LOF-RIF
 35A ROB-LIB
 35B LOB-RIB

These figures are started at a point where two circles meet at the long axis. The three turns are executed on the long axis at the top of each circle. The depth of the cusp of the three turn should be one skate length. The shoulders of the turn should be symmetrical with minimum deviation from the circle. The second curve should be the same size as the first. The "in-set" illustration shows the appearance of the three turn when both the outer and inner wheel tracings are seen.

Figure 7 has an additional turn, a two foot turn from inner back to outer forward (a choctaw), which is shown below. The skater should strive for a true choctaw, properly placed on the circles.

Figure 7 presents the skater with a new challenge offered only in this figure – a two-foot turn. By definition, a Choctaw is a two-foot turn in which the skater turns from one edge to the opposite edge. In the case of this figure, inside back to outside forward.

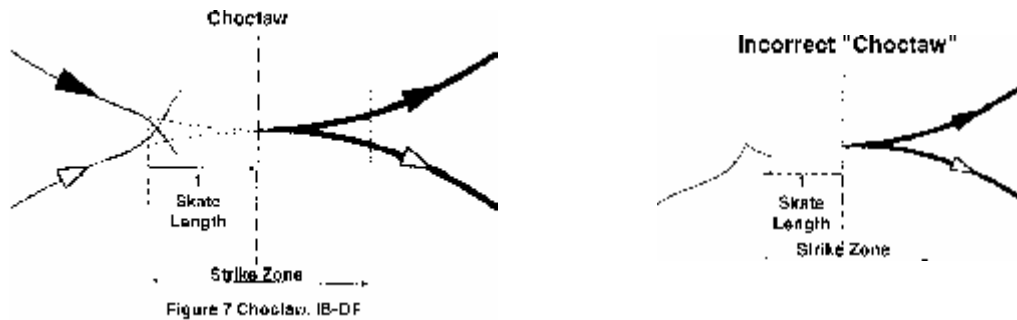

In the execution of this choctaw, skaters should strive for a pure inside to outside forward choctaw in which the inside back edge is held until the strike zone is reached, at which time the thrusting foot pivots and the rear wheels move into the next (new) circle. Ideally the thrusting foot pivots only until the toe and heel are parallel with the long axis; turning any farther creates a small, quick "counter" turn. Rotation at the close of the circle in preparation for the strike on the outer forward edge should be well controlled. The choctaw should neither gain nor lose speed. All other requirements of take-offs should be complied with: striking foot taking the floor at the intersection of the long and short axis; the thrusting foot not passing the long axis.

While there is no prescribed action of the free leg, the turns should be executed with a smooth, even rotation, not jumped or pulled. Every effort should be made to keep all four wheels on the floor. Some of the more common errors made in three turns are double leans, buckling, flats before and after, off axis and sub-curves.

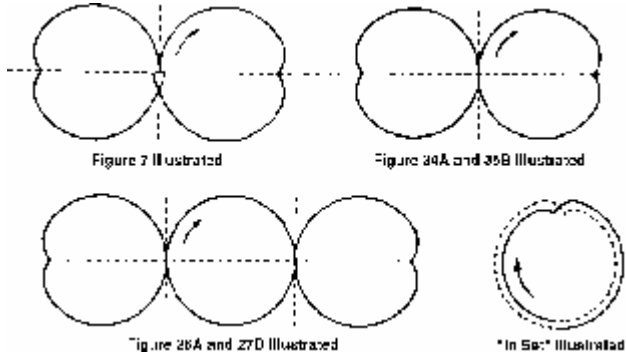

f. Double Threes

Figure 10A.....ROF-LOF

Eight 10B.....LOF-ROF

Threes: 11A.....RIF-LIF

11B.....LIF-RIF

12A.....ROB-LOB

12B.....LOB-ROB

13.....RIB-LIB

Serpentine Double Threes

Figure: 28A.....ROIF-LIOF

28B.....LOIF-RIOF

29A.....ROIB-LIOB

29B.....LOIB-RIOB

Paragraph Double Threes

Figure: 36A.....ROF-LIF

36B.....LOF-RIF

37A.....ROB-LIB

37B.....LOB-RIB

Double Three Figures have two consecutive three turns on the same foot and circle: One at the one-third point and the other at the two-thirds point around the circle. The middle curve cuts the long axis at right angles with the three curves of equal size. The cusp of all threes should point directly to the center of the circle being skated. Every effort should be made to keep all four wheels on the floor for the three turns. The individual parts of the figure should be symmetrically grouped around the axis.

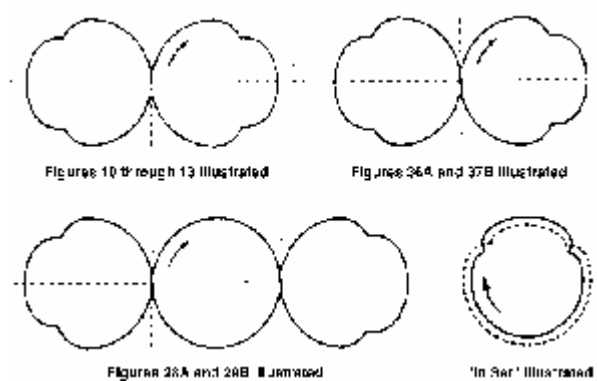

2. GEOMETRY OF A LOOP FIGURE

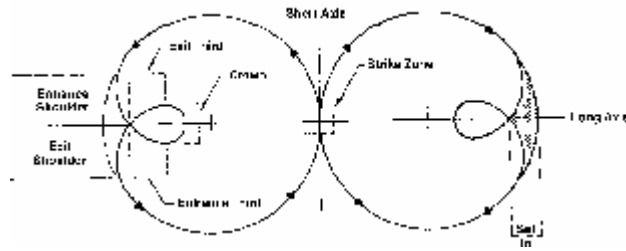

a. Loop

Figure: 14A.....ROF-LOF

Eight: 14B.....LOF-ROF

15A.....RIF-LIF

15B.....LIF-RIF

16A.....ROB-LOB

16B.....LOB-ROB

17A.....RIB-LIB

17B.....LIB-RIB

Serpentine Loop

Figure: 30A.....ROIF-LIOF

30B.....LOIF-RIOF

31A.....ROIB-LIOB

31B.....LOIB-RIOB

Paragraph Loop

Figure: 38A.....ROF-LIF

38B.....LOF-RIF

39A.....ROB-LIB

39B.....LOB-RIB

Loop figures are skated on 2.4-meter loop circles. The circles should be arranged on a long axis, similar to the eight or serpentine figure circles. Loops should be skated longer (approximately one-third of the diameter of the circle) than broad, without an angular change of curve. The second curve should be the same size as the first.

Errors often seen are circles instead of loops, uneven shoulders, off axis, buckling, double leans, pulling out too soon or too late and rocking action at the crown of the loop.

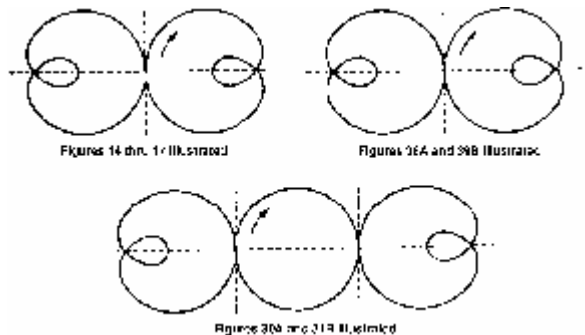

b. Bracket

Figure 18A.....ROF-LIB

Eight: 18B.....LOF-RIB

19A.....RIF-LOB

19B.....LIF-ROB

Serpentine Bracket

Figure: 32A.....ROIF-LOIB

32B.....LOIF-ROIB

33A.....RIOF-LIOB

33B.....LIOF-ROB

Paragraph Bracket

Figure: 40A.....ROF-LIF

40B.....LOF-RIF

41A.....ROB-LIB

41B.....LOB-RIB

The bracket should be turned on the long axis with the cusp pointing out of the circle and not exceeding one-half the length of the skate. The turn is a one-foot turn from a forward edge to a backward edge, or vice versa. Every effort should be made to keep all four wheels on the floor during a bracket turn. The rotation of the turn is contrary to the original edge. Brackets should be made without a change of edge before or after the turn. The curves should be the same size.

Some of the more common errors seen on brackets are: Flats before or after the turns, double leans, off axis, jumped turns, cutting off the top of the circle and pulled turns.

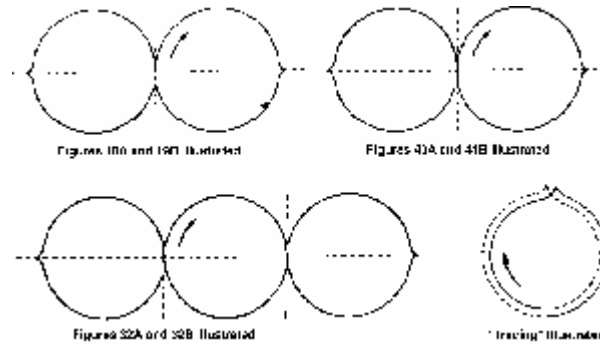

c. Rocker

Figure: 20A.....ROF-LOB

20B.....LOF-ROB

21A.....RIF-LIB

21B.....LIF-RIB

Rocker turns are a one-foot turn from a forward edge to a similar backward edge, or vice versa. The rotation of the turn is in the same direction (clockwise or counterclockwise) as the original edge. Every effort must be made to keep all four wheels on the floor during a rocker turn. Rockers should be made without a change of edge and the turns should be placed on the long axis with a cusp not exceeding one-half the length of the skate.

Errors common to rocker turns are: Double leans, changes of edge after the turn, flats before or after the turns, pulled turns, buckling and off axis.

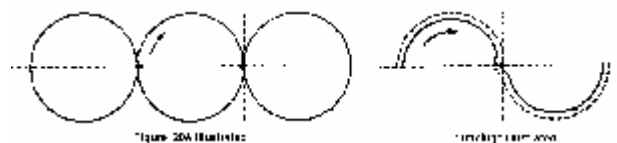

d. Counter

- Figure: 22A.....ROF-LOB
 22B.....LOF-ROB
 23A.....RIF-LIB
 23B.....LIF-RIB

Counter turns are a one-foot turn from a forward edge to a similar backward edge or vice versa. The rotation of the turn is contrary to the direction (clockwise or counterclockwise) of the original edge. Every effort should be made to keep all four wheels on the floor during a counter turn. Counters should be done without a change of edge and the turns should be placed on the long axis, with a cusp not exceeding one-half of the length of the skate.

Errors common to counter turns are: Double leans, buckling, off axis, pulled turns, flats before or after the turns and changes of edge.

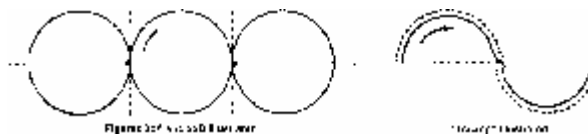

e. Serpentine Eight

- Figure: 111A...ROF-LOF
 111B...LOF-ROF
 112A...RIF-LIF
 112B...LIF-RIF
 113A...ROB-LOB

Execution of the serpentine eight requires the skating of a half circle before taking off again for the skating of a full circle. One full repetition consists of a strike-off, half circle, take-off, full circle, take-off, half circle, take-off, full circle. A skater has completed the figure when he or she has performed one strike-off and seven take-offs. In the diagrams below, the right foot is the heavier line.

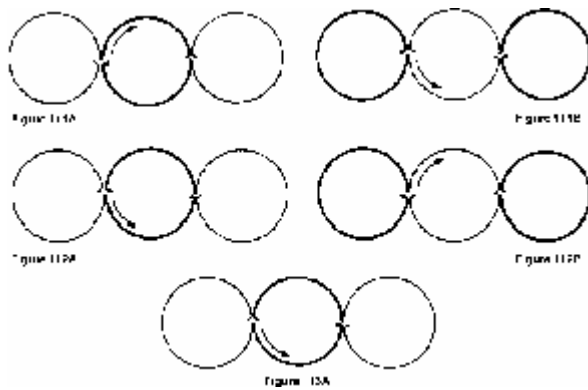

f. Loop Circle Eight

- Figure: 114.....ROF-LOF
 115.....RIF-LIF
 116.....ROB-LOB
 117.....RIB-LIB

Loop Circles are skated like circle eight figures, except they are skated on 2.4-meter loop figure circles.

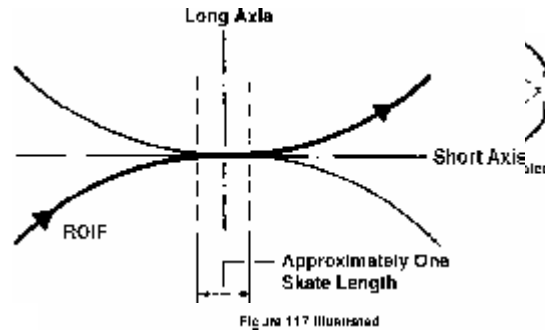

g. Serpentine Loop Circle

- Figure: 130A... ROIF-LIOF
- 130B... LOIF-RIOF
- 131A... ROIB-LIOB
- 131B... LOIB-RIOB

Serpentine loop circles are skated like serpentes, except they are skated on 2.4-meter loop figure circles.

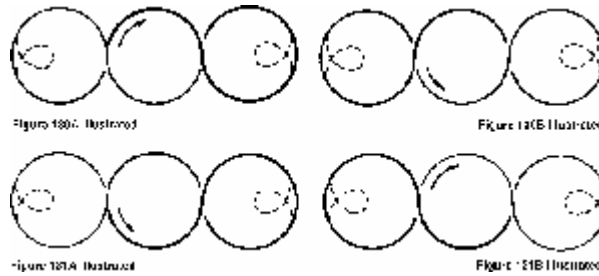

h. Paragraph Loop Circle

- Figure: 138A... ROF-LIF
- 138B... LOF-RIF
- 139A... ROB-LIB
- 139B... LOB-RIB

Paragraph loop circles are skated like paragraph eights, except they are skated on 2.4-meter loop figure circles.

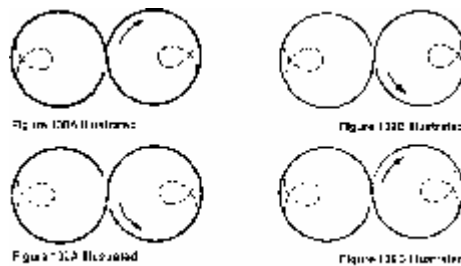

ARFG-D GUIDELINES FOR SKATING AND JUDGING FIGURES

I. Change of Edge

Change of Edge (abr. C-E) - A change of curve from outside to inside or vice versa on one foot, without a change of direction of the skate.

- a. All changes of edge should be made at the intersection of the long and short axes, with a smooth, even transition.
- b. A good change of edge will produce a flat, approximately the length of the employed skate.
- c. There is no prescribed action of the free leg on changes of edge.

2. Common Faults on Changes of Edge

- a. Pulling change of edge and gaining speed on the change.

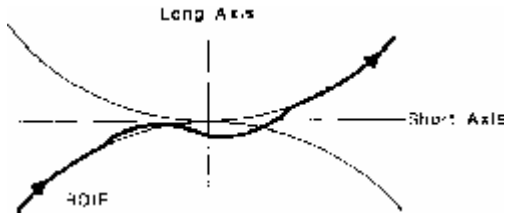

- b. "S"ing change of edge.

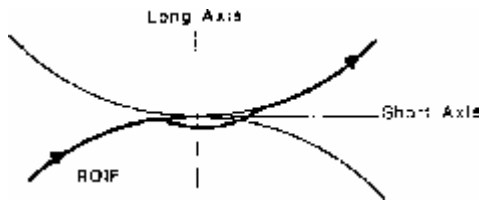

- c. Oblique or cutting both sides of change.

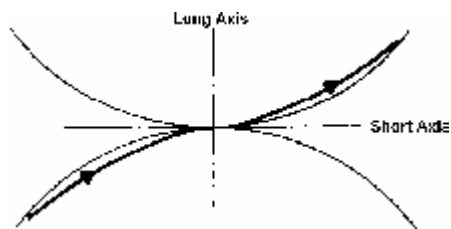

- d. Wobble, either before or after change.

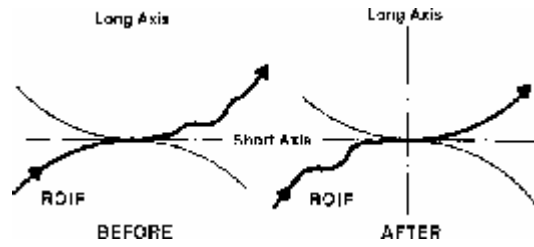

e. Cutting across flat on second side of change.

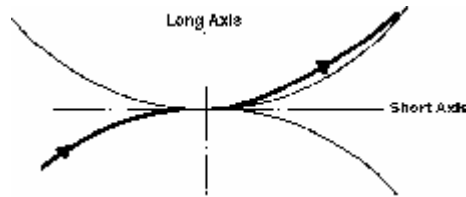

f. Cutting across flat on first side of change.

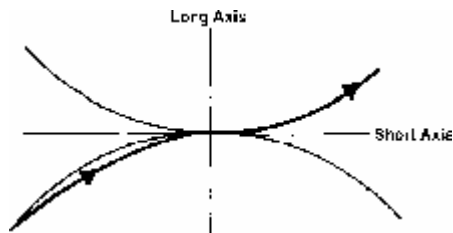

g. Flat too long. (Held more than length of skate.)

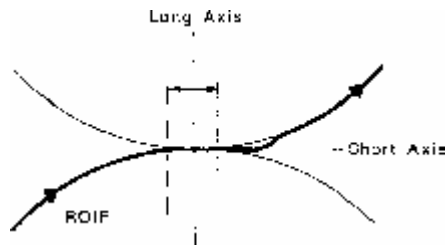

3. Three Turns

Figures 7A-B, 8A-B, 9A-B, 26A-B, 27A-B, 34A-B and 35A-B

Cusp - The point of intersection of, and the two small curves, comprising the deviation from the arc. The point of any one-foot turn.

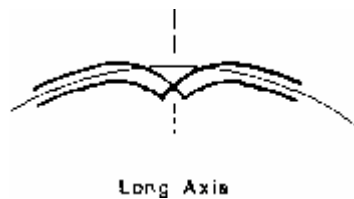

Three (abr. 3) - A one foot turn from a forward edge to an opposite backward edge or vice versa, with the rotation in the direction of the initial edge, and with the cusp inside the circle.

- a. Threes should be made with the turns placed on the long axis.

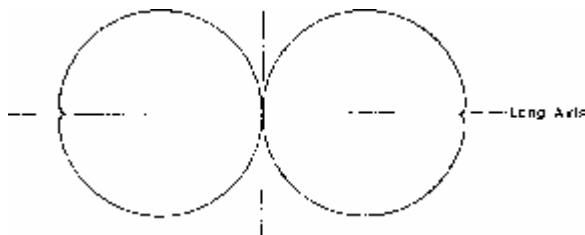

NOTE: Figure 7 has a Choctaw Turn in it, which must be an IB to and OF edge with no rockover, and the trusting foot leaves the floor by the long axis.

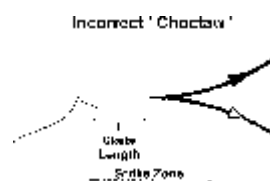
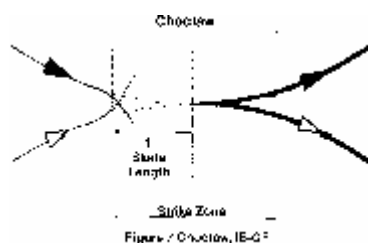

- b. The depth of the cusp of the Three Turn shall be one skate length.

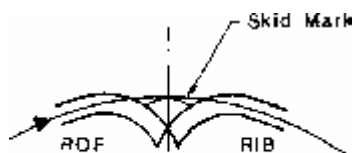

Long Axis

- c. On Threes, the entrance edge should be held right up to the precise instant of turn, with the new edge assumed when the skate is going away from the long axis.
- d. Three Turns should be done with complete control over the skate at all times, so an even flow or roll through the turn is desired. NOTE: The skate should not stop during the turn. The speed of the entry and exit from the turn should be even. There should be no jerky forward-backward motion on turns.
- e. Judges should place themselves in position to see the turns. The cusps should be one skate length aiming to the center of the circle.

4. Drawings of Problems on Threes and Judging Priorities

- a. Turn not pointed to center of the circle.

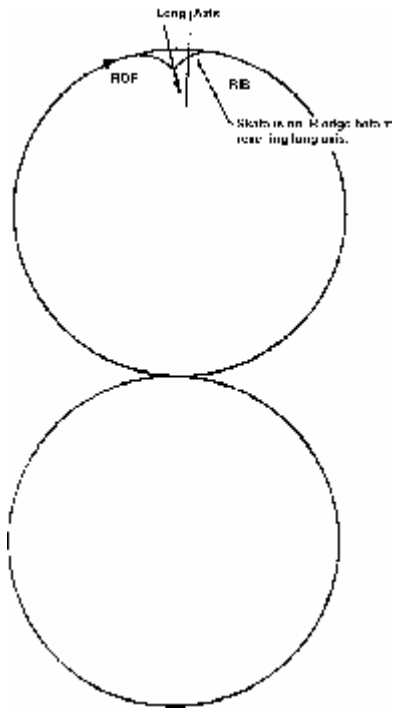

b. Change of edge before Three most common

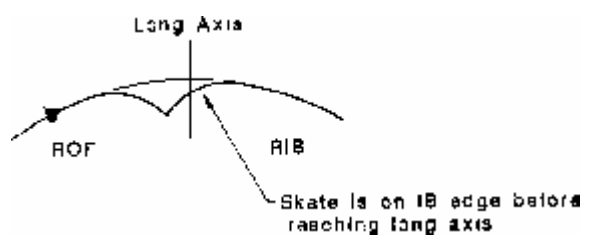

c. Wobble after Three

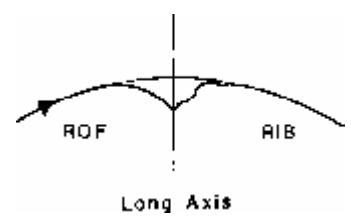

d. Hooked Three

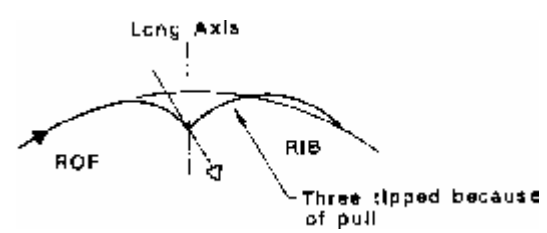

NOTE: Most common error especially in second turn of Double Threes. Pull usually from loss of balance; the skater did not turn around far enough on first curve and has to pull himself out of bad position.

Indication of fault is: Increased speed on exit of turn.

- e. Flats both side of Three



- f. Long forced edge before turn

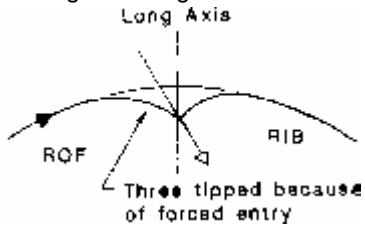

- g. Flats before Three

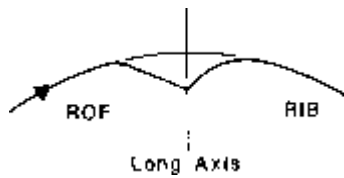

- h. Bulge after turn

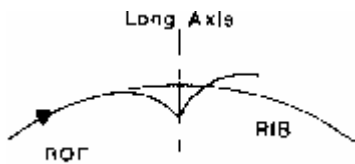

NOTE: Probably an error even worse than falling in (depending on how far), because if the skater went out, he probably hit the wrong edge afterwards.

- i. Flats after Three



j. Shallow exit after Three

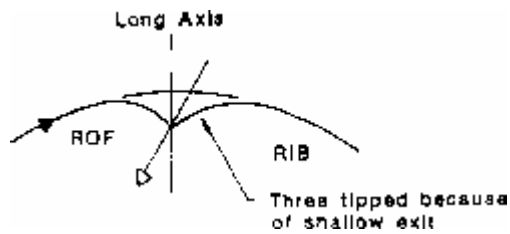

k. Change of edge past Three

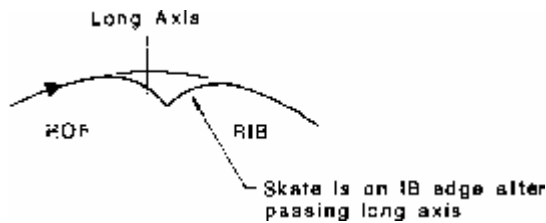

5. Observations of Double Threes

- a. Judges do not only observe one turn to see if the shoulders of that single turn are even on double threes; they must observe and compare the relative sizes of two different turns. NOTE: The distance from the center of the ankle to the toe is much greater than from the ankle to the heel. For this reason, back turns have a tendency to be executed quicker than forward turns, since in turning backward, the foot has less distance to travel than when turning forward. This is the reason that by their very nature forward turns have larger, slower cusps than backward turns. The ability to produce Double Three Turns evenly, matching the size of the forward and backward turns with an even speed of entry and exit, must be rewarded by the judges.
- b. Inside Threes have a tendency to have longer entry cusps than exit cusps.
- c. Outside turns have a tendency to rockover early before the turn.
- d. For the forward Double Three, the middle arcs and the second threes are skated backward, so the judge will position himself so as to readily observe the backward arc and the second backward three.
- e. For the backward Double Three, the more difficult parts are the backward take-offs and the first Threes. In this case the judge will take a position so as to readily observe these sections.
- f. Flow and roll of the skate is important in all figures, but in Paragraph Double Threes, pulls out of turns, or in the changes or any other artificial or incorrect means of maintaining speed, are serious faults for which judges must penalize.
- g. On Paragraph Threes, if the first turn is taken too fast, the following section of the figure sometimes lacks control. Good roll for the second turn is often lacking, causing sub-curves or flats.

- h. In the Forward Paragraph Double Threes, the second and fourth Threes are skated backward and hence are trouble spots, being frequently placed off axis. A judge will position himself so that he can observe the placement of the second and fourth Threes.
- i. In the Backward Paragraph Double Threes, the take-offs and changes of edge are backward, thereby making the positioning of the first and third Threes difficult. Judges will position themselves for a good view of the first and third Threes.
- j. Consistent pace and flow throughout the Three Turn Figures is a sign of the symmetry in the shoulders of the Three Turns.
- k. Judge should place themselves in position to see the turns. The cusps should be one skate length aiming to the center of the circle.

6. Drawings of Common Errors on Double Threes and Judging Priorities

- a. Both Threes not pointing to the center of the circle.

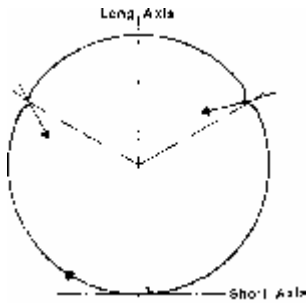

NOTE: If the first shoulder of the Three has a long flat, the Three will point in the opposite direction from the above diagram.

The first Three, a forward one, has a much flatter, longer, second shoulder.

The second Three, the backward turn, is the same type of error, but this illustrates where the Three points on the same flat exit.

- b. A long flat caused by early departure from the radius of circle in and out of turn.

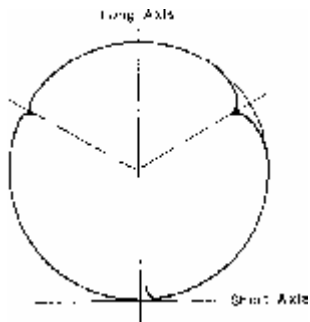

NOTE: One of the most common errors on Double Threes.

- c. Cutting the circle off after three.

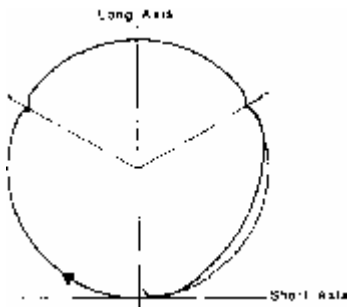

NOTE: The closer to the Three this happens, the more serious the error.

- d. both turns off axis; both early

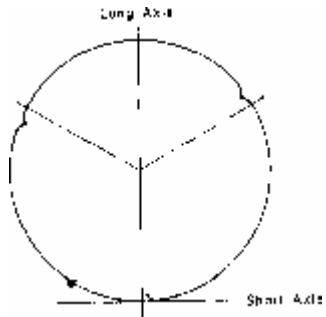

NOTE: This is the most common error in the placement of Double Threes.

- e. Bulge out before second Three

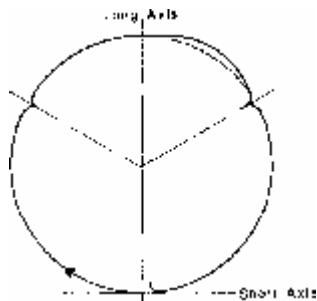

NOTE: This error is another common error, and is compounded if the lean goes outside the circle and/or the skater rocks over before the turn.

- f. Bulge out over top of circle

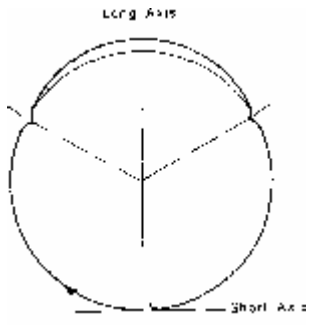

g. Wobble across top of circle

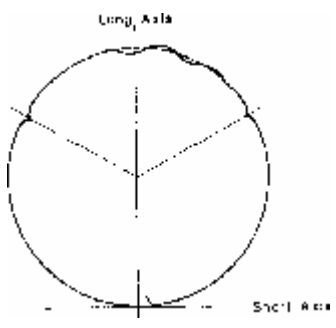

h. Flat across top of circle

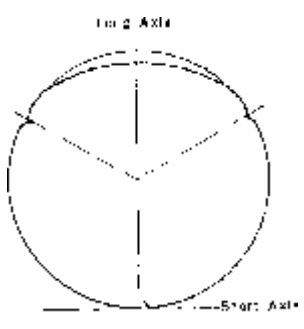

i. First turn off axis early

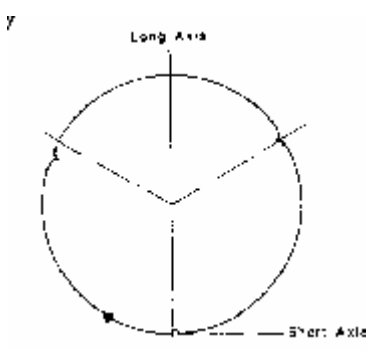

7. Brackets

Figures 18A-B, 19A-B, 32A-B, 40A-B and 41A-B

Bracket - A one foot turn from a forward edge to the opposite backward edge or vice versa; the rotation of the turn is contrary to the original edge.

- a. The Bracket should be turned at the long axis with a cusp pointing out of the circle, not exceeding one-half the length of the skate.
- b. Brackets should be made without a change of edge before or after the turn and the first and second curves should be of the same size.
- c. The Bracket turn is not a natural turn; while the body is leaning into the main circle, the skate is forced to curve in the opposite direction and away from the center of gravity. This turn requires a quick, precise turn in a short space.

8. Important Tips on Brackets

- a. In the forward to backward Brackets, there are likely to be errors during the preparation for the turns. Errors before Bracket turns are serious because they incorrectly facilitate the making of the turn. In extreme cases, a change of edge may even occur before the turn. NOTE: Keeping this in mind, a good position for a judge to observe Brackets would be on the side of the figure nearest to the skater's approach to the Bracket, but not excluding the view of the exit edge.
- b. In the backward to forward Brackets, there are likely to be errors on the exit edges. Judges will be alert that a change of edge frequently occurs here.
- c. Flow and roll of the skate is very important on Paragraph Brackets. Once again, pulls out of the turns or in the changes or any other artificial or incorrect means of maintaining speed are considered serious faults.
- d. In the forward Serpentine Brackets and also the forward Paragraph Brackets, bulges out after the first turns are common.
- e. In the backward Serpentine and Paragraph Brackets, skaters often cusp inward to make the first Bracket.
- f. Inside Brackets are often more shallow than outside Brackets. Even cusps on inside and outside Brackets are quality points which will be rewarded by the judges.
- g. There is not prescribed free leg action on Brackets.
- h. Bracket turns should be done on four wheels.

9. Drawings of Brackets and Judging Priorities

Correct Bracket

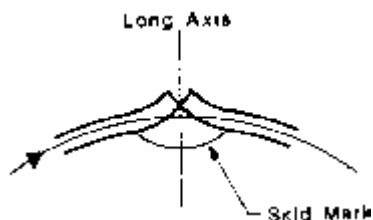

The correct bracket is one-half skate length.
Turn points are out of the circle at the long axis.

- a. Rockover after turn; the first edge is held past the long axis. Turn points in the wrong direction.

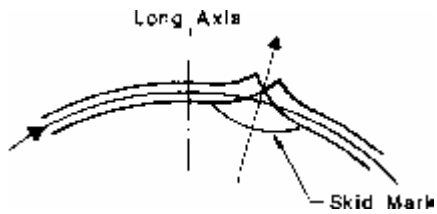

- b. Rockover before turn; the second edge assumed before the long axis; the entry cusp shoulders are deeper than the exit cusp shoulders. The turn points in the wrong direction.

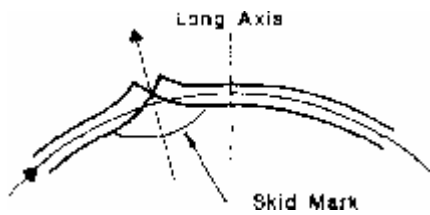

Note: A common fault on forward turns.

- c. Sub-curves after Bracket

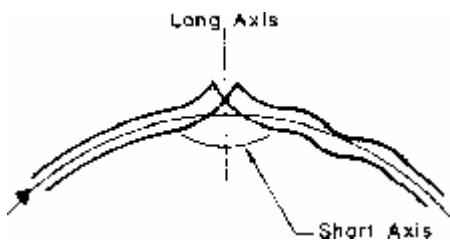

- d. Sub-curves before Bracket

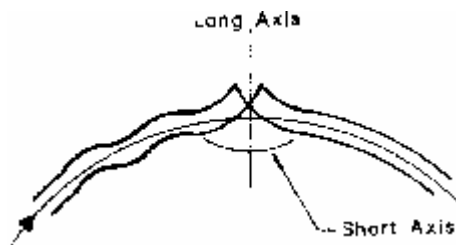

- e. Long flat after turn; insufficient rotation. Turn points in wrong direction.

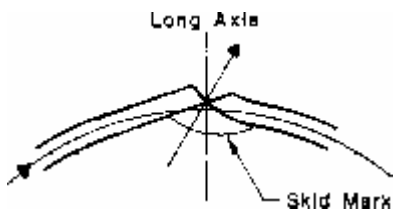

- f. Turn points in wrong direction; hooked Bracket; the second cusp is pulled back to the line too abruptly.

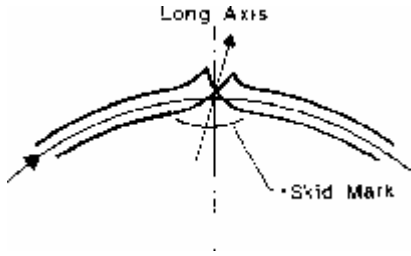

g. Long flat after turn; a failure to stop rotation. Turn points in wrong direction.

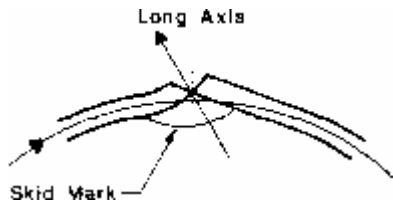

h. Bracket cuts in before turn.

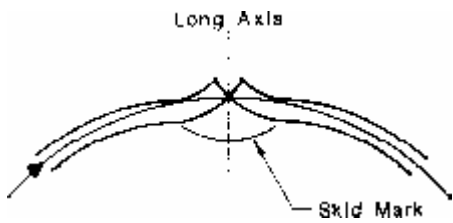

NOTE: A common fault on the OB Brackets.

i. Flat Bracket

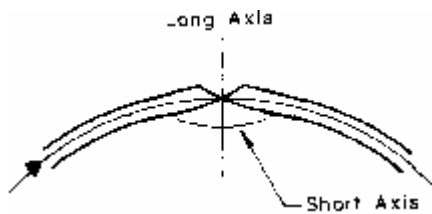

NOTE: This is a common error. The Bracket would be unduly small in relation to the size of the skater's foot. This is usually characterized by not keeping the weight to the center of the circle being skated; the lead rollers would not have left the line.

10. Counters

Figures 22A-B and 23A-B

Counter (abr. Co) - A one foot turn without a change of edge, in which the rotation is counter to the direction of the initial edge.

- The Counter should be accomplished without a change of edge and the turns should be placed on the long axis, with a cusp not exceeding one-half the length of the skate.
- There is no prescribed free leg action.

11. Important Tips On Counters

- a. There should be no flats or sub-curves before or after Counter turns.
- b. The judges will watch for either pulls at the turns (picking up speed) or losing speed in turns.
- c. Counter turns should be quick and precise, with an even roll throughout the turn.
- d. Counter errors are more likely at the entrance edge. A judge will take a position opposite the center circle to have a good view of both sides of the turn, but in particular, the troublesome entrance edge.
- e. Artificial and incorrect means of maintaining speed on Counter turns are serious faults.
- f. Everything violent, stiff or angular is to be avoided.
- g. Counter turns should be done on four wheels.

12. Drawings of Counters and Judging Priorities

Correct Counter

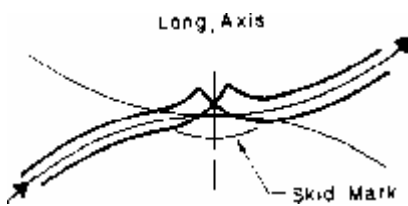

- a. Change of edge before the turn (actually a Three turn)

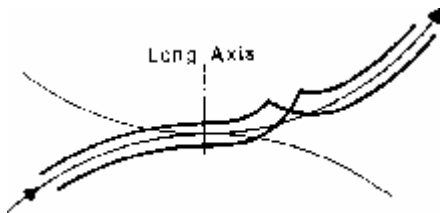

NOTE: This is the most common error in Counters.

- b. Sub-curve after Counter

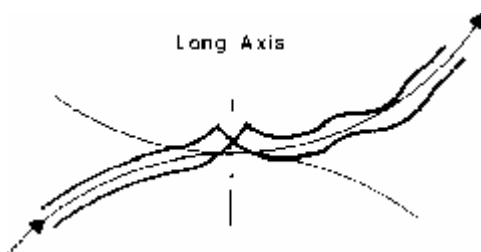

- c. Sub-curve before Counter

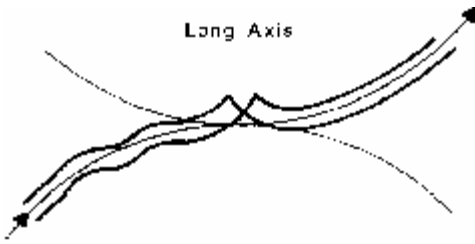

d. Counter off axis

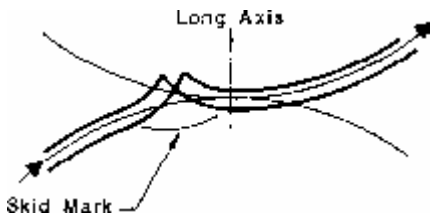

e. Long flat on entrance side of Counter, another common error

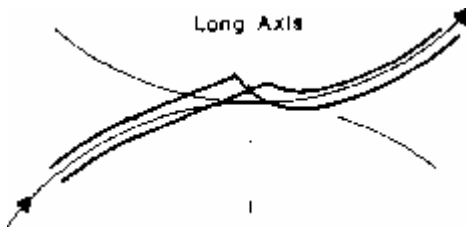

NOTE: an extreme flattening of lean before the turn or the existence of a double lean can observe this before the turn.

f. Long flat on exit side of Counter



g. Flat Counter

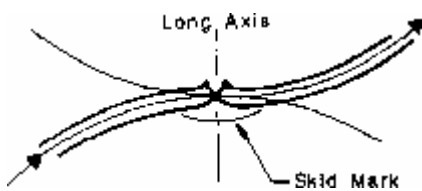

NOTE: Counter would be unduly small in relation to the size of the skater's foot. This can be observed through an extreme flattening of lean before the turn, or a double lean before the turn. The lead wheels will not leave the line.

13. Rockers

Figures 20A-B and 21A-B

Rocker (abr. Rk) - A one-foot turn from a forward edge to a similar backward edge, or vice versa, with the turn rotation continuous in the direction of the initial edge, and with the cusp inside the original circle.

- a. Rockers should be made without a change of edge and the turns should be placed on the long axis with a cusp not exceeding one-half the length of the skate.
- b. There is no prescribed free leg action.

14. Important Tips on Rockers

- a. There should be no flats or sub-curves before or after Rocker turns.
- b. Judges will watch for either pulls at the turns (picking up speed) or losing speed in turns.
- c. Rocker turns should be quick and precise with an even roll throughout the turn.
- d. Rocker errors are more likely to be made in the exit edge. Judges will take a position opposite the center circle and from this vantage point observe both sides, and in particular, the troublesome exit edge.
- e. On Rocker turns, any artificial and incorrect means of maintaining speed are serious faults.
- f. Everything violent, stiff or angular is to be avoided.
- g. Rocker turns should be done on four wheels.

15. Drawings of Rockers and Judging Priorities

Correct Rocker

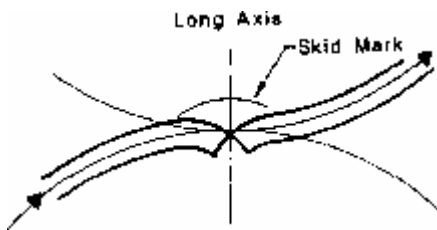

- a. Edge too deep, too soon; an improper edge was taken before assuming the correct edge; a change of edge after the turn (Three turn)

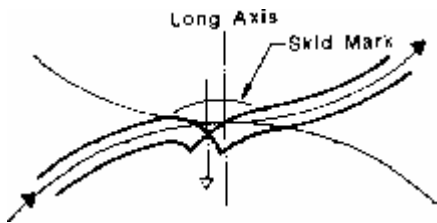

NOTE: Most common fault in Rockers

- b. Change of edge before turn.

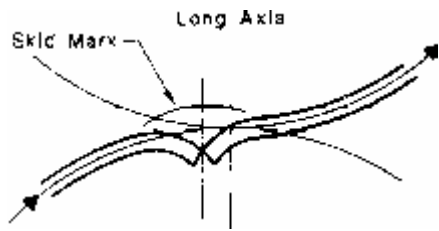

c. Sub-curve after Rocker

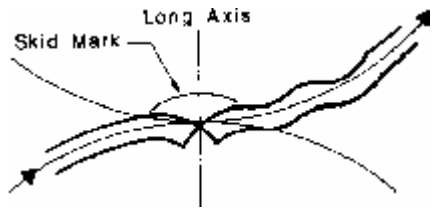

d. Sub-curve before Rocker

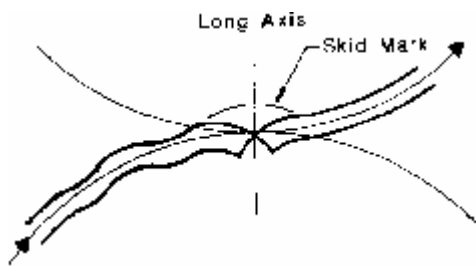

e. Long flat after turn

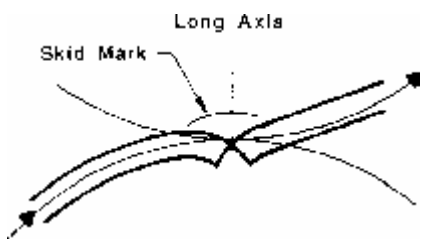

f. Long flat before turn

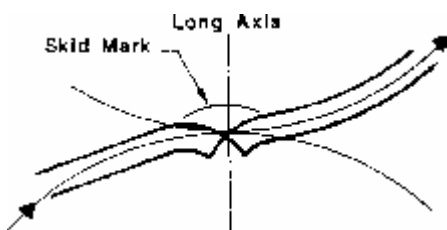

g. Flat Rocker; flats on both sides of the Rocker

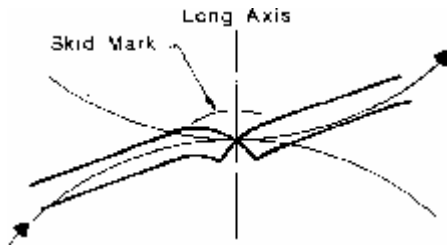

NOTE: This turn is characterized by double leans or lean being unduly flattened during the turn. The cusp will be unusually small for size of the foot. The lead rollers will not have left the line.

h. Late off axis turn

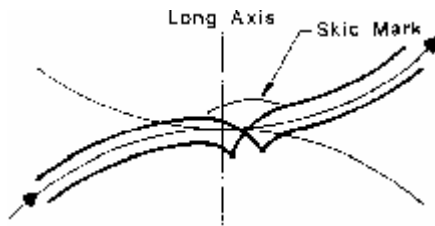

16. Loops

Figures 14A-B, 15A-B, 16A-B, 17A-B, 30A-B, 31A-B, 38A-B and 39A-B

Loops - Are skated on two or three circles and the loops should be longer (approximately one-third of the diameter of the circle) than broad, without an angular change of curvature, with their long axis same as the eight and the second curve should be the same size at the first.

Judging Points:

- a. Edge Quality
- b. Loop Execution
 - (1) Loops should be judged for size and shape in conformity with the printed pattern on the skating surface.
 - (2) Pace - Loops should have an even roll of the skate, both on entrance and exit.
 - (3) Body Posture baseline should be maintained throughout the loop.
 - (4) Correct loop tracing will require that both leading and trailing trucks trace on the crown of the loop.
- c. Strike-off and take-offs
- d. Body posture baseline throughout the tracing of the entire figure
- e. Pace and flow throughout the tracing of the entire figure.

Tips:

- a. A judge should take a position so as best to observe pulls, either out of the loops or on the change of edge.
- b. A judge should take a position to see touch down of the free foot in order to evaluate their severity.
- c. A judge should observe that the crown of the loop is rolled on an edge on the line, with even roll of the skate.

Common Errors:

- a. Poor Edge Quality. Most common tracing errors and problems with edge quality occur after strike-off and take-offs.
- b. Poor execution of loop.
- c. Poor strike-off and take-offs.
- d. Poor body posture baseline.
- e. Inconsistent pace.

17. Drawing of Loops

Correct Loop

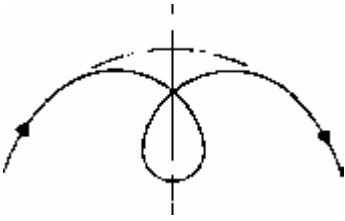

a. Circle Loop; not long enough; too wide for its length

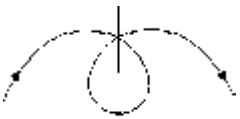

NOTE: Common Loop error. Round Loops can be rolled through smoothly, so judges must watch closely for proper shape. Loop will be too wide and will not be long enough.

b. Pointed Loop



NOTE: Common errors due to stoppage of continuous roll in Loop

c. Cutting off crown of Loop

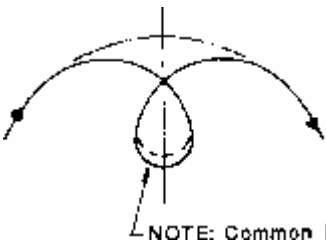

d. Sub-curve after Loop

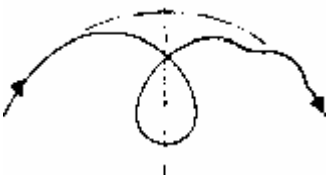

e. Sub-curve before Loop

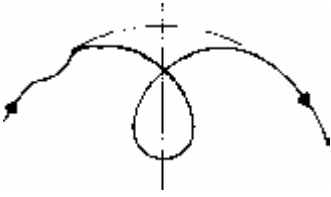

f. Cutting off exit side of Loop

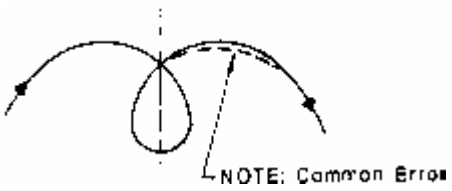

g. Exit of Loop too full

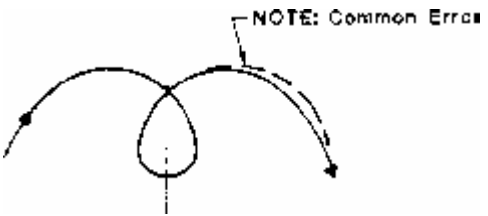

h. Cutting off entrance side of Loop

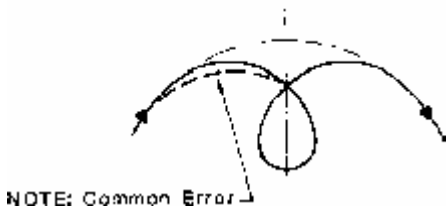

i. Entrance of Loop too full.

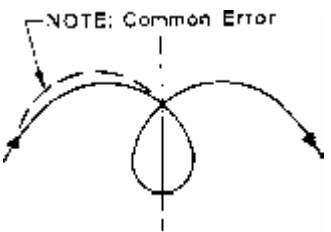

18. FIGURE SKATING PRECEPTS

In all competitive figure events, judges must consider the following applicable points:
Start

Tracing
 Turns/Loops and/or Change of Edge
 Second Turn
 Placement of Turns
 Tracing after/between Turns
 Circle Closure
 Subsequent Take-Offs
 Concluding Figure

Form must be given the required full consideration throughout the skating of the entire figure.

Each figure contains turns, take-offs, etc., of specific difficulty. These factors must be given due consideration in determining the score while still giving full consideration to the other judging points of the figure. The major faults of figure skating and their corresponding point deduction include:

- a) Putting the free foot on the floor will cause the assigned score to be reduced a minimum of **10 points**.
- b) Falling on a figure will result in the assigned score being reduced a minimum of **20 points**.
- c) Unwarranted rock-overs or changes of edge, producing an incorrect turn, shall be penalized according to the degree of the error.
- d) An incorrect turn, a three turn instead of a bracket, or a rocker instead of a counter, will be assigned a score reduction of a minimum of **20 points**.

It is the responsibility of the referee to inform the judges of these major faults immediately after the involved skater has finished the figure.

Establishing a pure edge, even one that is not on the line, is the most important part of tracing. Tracing, even though on the line, which is effected at the expense of edge quality (skate wobble), shall be penalized. The momentum of the figure is evaluated by the consistency of edge and speed.

19. SUMMARY

Roller Figure Skating has more to offer than any other type of figure skating. There is no need for forced or strained positions to produce accurate roller tracings. Judges should not just be aware of conventional correctness, but also to the extra refinements of roller figures. In roller figures, the beauty of movement, the positions of head, arms, hands and the general grace should be used in competition as an added means by which to distinguish between skaters who differ markedly in such respects.

The technical method used for the execution of a figure has nothing to do with beauty or correct tracing. It is no concern of the judge whether one shoulder or the other appears to be leading, nor whether the free leg is carried forward or back at any particular point. All that kind of thing has to do with figures is the different methods of teaching or with individual preference. All that should influence the marks awarded by the judge is correct tracing, edge quality, smoothness and general appearance of the skater, and not the particular method used to achieve this final result.

ARFG-E HOW TO DRAW FIGURES ON THE RINK FLOOR

In marking the figures on the rink floor, it is imperative to place the centers of all the circles in an exact line along the long axis. Use a chalk line to mark the long axis on the floor.

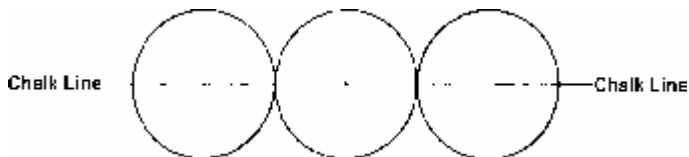

The above figure is called a serpentine. It is the standard figure used in roller figure skating.

Circles should be joined so that the widths of the painted lines are superimposed to form one width at the intersection of the two circles. Lines drawn through the exact center of the widths should just touch at the point where the circles meet the long axis.

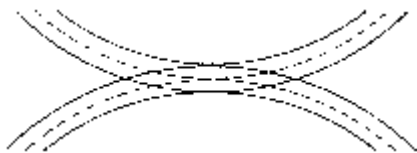

The USARS official dimension of competitive figure circles, measured at their diameter, along the long axis, is six (6) meters for all standard figure circles and 2.4 meters for loop circles.

Individual sets of figure circles should be arranged on the skating floor so that they do not overlap. For versatility, it is better to put down figure circles in serpentine patterns, rather than figure eight patterns. All figures should be marked in a contrasting color from the floor, so that the figures can be easily seen by the skaters and the judges. The lines for figures should not be less than one-half (1/2) inch nor more than three-quarters (3/4) inch in width.

Metric to Feet Conversion

Loops: 2.4 meters or 7 feet, 10-1/2 inches

Standard Circles: 6 meters or 19 feet, 8-1/4 inches

To mark the figures on a skating floor, use a wide felt tip marker or long bristle paint brush. If not using a marker, liquid black spirit shoe dye can be used, rather than paint. If the figures are laid down on the floor before applying clear floor finish, the figures will not have to be redone until the floor is resurfaced.

As a compass for laying figure circles, we suggest the use of a 1x2-inch board, at least ten feet long. Nail a short piece of board to the end of the long board. To the bottom edge of the short board, glue or nail a length of one-half inch wide felt weather stripping. Next, measuring from the center of the short board, drill three holes in the long board at a distance of 1.2 meters for loops and 3 meters for the standard circles. These holes will form the radii of the circles to be inscribed on the skating surface.

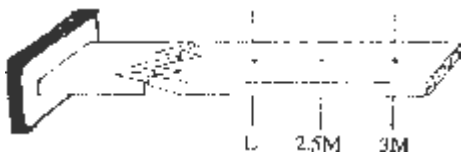

To use this compass, first begin by snapping a chalk line long enough to accommodate the common diameters of three circles of the size desired. Drive a finishing nail into the floor along the chalk line to form the center of the first circle to be inscribed. Slip the appropriate hole that has been previously drilled in the compass, over the nail. Dip the felt pad at the end of your compass in a shallow dish or pan containing your marking fluid or paint. Blot, and then lower onto the skating surface and continue moving the stick until the felt needs to be recharged. It is important that the pad be lightly blotted and kept in constant motion while in contact with the skating surface to avoid over saturation and blotchy lines.

ARFG-F INSTRUCTIONS FOR MAKING LOOP CIRCLES ON THE SKATING FLOOR

Loops should be laid out with three loop circles in a row, all having their centers along a long axis, tangent (touching at the intersection with the long axis) and oriented as shown below with the loop of the two end circles facing out.

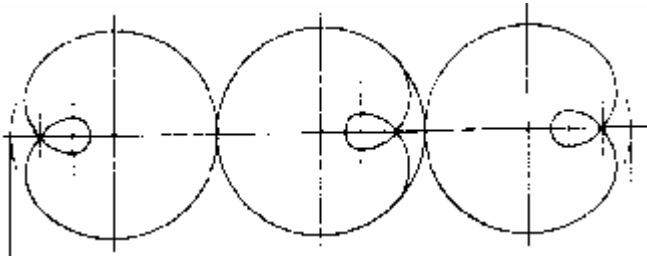

In the drawing (see diagram on next page), the broken line D-A-B is an arc of the circumference of the loop circle, and is necessary in the layout before the painted tracing line is made. When the painted tracing is made, the arc is not painted on the two end circles; however, this arc is painted on the center loop circle.

A paper pattern of a quarter section of the complete loop is available from USARS Headquarters. (Call USARS for information and pricing.) This pattern can be used to make a plywood or masonite template, greatly simplifying the laying out and drawing of loop figures.

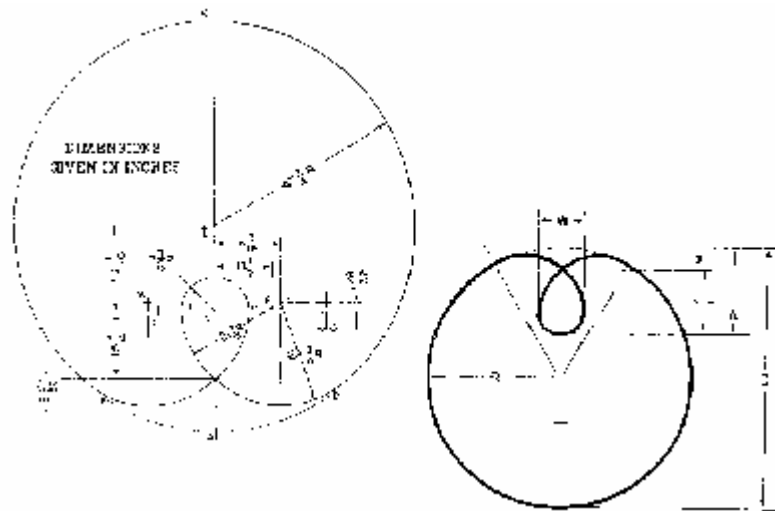

Loop Dimensions	Inches	Centimeters
D-Diameter of Loop Circle	94.5	240
SI-Set In of Loop (1/8 D)	11.8	30
LL-Length of Loop (1/4 D)	23.6	60
A-Length of Loop plus Set In	35.4	90
W-Width of Loop (1/6 B)	15.75	40

Note: These dimensions are based upon a single line, and not upon the width of a skate or the half-inch width of the painted lines.

If you are going to draw a loop without the above pattern from the National Headquarters, use the following instructions. Unless you are experienced in painting loop figures, it is best to lay out the complete drawing in pencil first.

- a. Make a reference axis line (A-X) long enough for three 94-1/2" circles in tangent sequence. A chalk line can be used because this axis line will not be painted.

- b. You will need a device long enough for a $47\text{-}1/2$ " compass setting to outline the three loop circles in sequence. A pair of "trammel points" on a $1" \times 3/4$ " piece of wood, approximately 50" long, makes a suitable beam compass. Locate the center, "C", on the axis line and use "C" as a compass center for the radius of the loop circle.
- c. Use illustration diagrams to scribe the arcs of the loop and its set in. Note that point "L" takes the set in arc from the circle circumference to a point where it merges with the arc inscribed by point "F". Point "F" will then bring the loop arc from the termination of point "L" to point "H" ($19\text{-}11/16$ " from a line at right angles to the center of the circles). Point "K" then inscribes the bottom of the loop from "H" to "G". The spiral out is the reverse of the foregoing using points "E" and "M". Again, it is suggested that a loop be rendered on a masonite or plywood pattern to facilitate transferring to the skating surface.

AMERICAN ROLLER DANCE SKATING

ARD-A PRINCIPLES OF AMERICAN DANCE

1. American Dance is a discipline of Roller Skating which involves one person or two people skating together doing prescribed steps.
2. American Dance is a discipline of Roller Skating which develops and defines the fundamentals of correct skating.
3. In American Team Dance, the measure of excellence is shared by the harmonious performance of skating movements by the partners, and the accuracy of executing the prescribed requirement of each movement and dance.
4. American Solo Dancers aspire for the same degree of excellence without the company of a partner.

ARD-B JUDGING CRITERIA

1. The judging and skating of American Dance is predicated upon the following requirements, listed in their order of importance:
 - a. Timing to the music.
 - b. Execution of basic fundamentals and technical requirements.
 - c. Pattern of the dance.
 - d. Correct body positions, including team unison.

Only after all four of these requirements have been satisfied will consideration and credit be given to the:

- e. Artistic impression of the dance.
2. **Planing**
By definition, planing is a system of body inclination employing horizontal and parallel alignment of the head, shoulders, and hips.
3. **Posture Baseline**
By definition, a posture baseline is an imaginary line from the center of the skating foot through the hip line and shoulder line.
4. **Body Position**
When skating American Dance, it is absolutely mandatory that your body be perpendicular to your tracing, except during the execution of one-foot and two-foot turns. This perpendicular relationship is commonly referred to as being "square to your tracing".
5. **Take-offs**
 - a. By definition, a take-off is the beginning of a new edge, or flat, from another edge, or flat.
 - b. There are two (2) types of take-offs: parallel take-offs and angular take-offs.
 - c. A parallel take-off is one in which both feet are directly alongside each other and on the same arc at the instant of weight transfer. Parallel take-offs are used when going from: an outside edge to another outside edge, an outside edge to an inside edge, an inside edge to an outside edge, and a flat to another flat.
 - d. An angular take-off is one in which the skate to be employed takes the floor on an arc or flat divergent to the arc or flat being skated. Angular take-offs are used when going from: an inside edge to another inside edge, and an outside edge to another outside edge that is crossed behind or crossed in front

6. “Parallel And” Position

The “parallel and” position is a position immediately alongside and parallel to the tracing skate.

7. “Angular And” Position

The “angular and” position is a position immediately alongside and angular to the tracing skate.

8. Steps

By definition, a step is the transference of body weight from one foot to the other. Every step must take the floor in either the “parallel and” position or the “angular and” position, except those that are:

- a. crossed in front
- b. crossed in back
- c. in-line
- d. the second half of an open 2-foot turn

Failure to do so is a serious error in American Dance skating and must be severely punished by the judge.

9. Crossed Steps

Crossed Steps must take the floor with the heel wheels of one skate at least alongside the toe wheels of the other skate. The tracings of the two skates must overlap. The tighter the cross, meaning the closer the skates are to each other, the better the movement. Failure to do so is a serious error in American Dance skating and must be severely punished by the judge.

10. Progressive Step

A progressive step is a step that passes the old tracing foot in the direction of travel.

11. Progressive Running Steps

Progressive running steps are a series of progressive steps on successive beats of music not involving cross steps or changes of direction.

Progressive Stroke versus Place Stroke

When your free foot is in a leading position and the next step is required to take the floor in the “and” position, it is equally correct for:

- a. the free foot to be brought back to the “and” position (in the air) before stepping into the “and” position, or
- b. the free foot to be brought back past the “and” position (in the air) before stepping into the “and” position.

12. Chasse’

A chasse’ is a step that does not pass the old tracing foot.

13. Stroke

By definition, a stroke is a step executed so as to impart momentum, which is synonymous with saying, a step executed so as to provide thrust or power. Therefore, chasse’ steps are not strokes and some, but not all progressive steps are strokes.

14. Baseline

By definition, a dance baseline is a real or imaginary reference line around which the lobes of a dance are built. It separates the barrier lobes from center lobes. Adherence to the baseline must be absolute. There is no allowable deviation from it. The team or skater that misses the baseline by even a small amount is in error. However, they are better than a team or skater that misses the baseline by a greater amount.

15. Rockover

By definition, a rockover is a preparatory change of lean to permit a graceful transition from one lobe to the next lobe. Every rockover must occur on the baseline. The rockover should occur as late as possible before the next lobe, yet it should be as early as necessary for the skater to effect a graceful transition to the next lobe.

16. Swing

By definition, a swing is a controlled movement of the free leg from a trailing position to a leading position, or vice versa, with both positions matched as to height from the skating floor, relation to the body, and relation to the employed skate.

17. Timing

- a. Timing for Skate Dancing is the harmonious relationship between the team or solo movements in executing the correct fundamentals of skating and the specified requirements of the dance to support the musical accompaniment. As a primary fundamental, harmonious relationship would require that the proper steps be skated on the proper count and are sustained for the proper number of beats. Timing is of paramount importance. It is the single most important factor in the dance.
- b. To be “out of phrase” with the music, e.g. to skate a step on beats 3-4-1-2 when it is listed as 1-2-3-4, is an error. However, it is not as bad as being out of time with the music but it is not as good as being “in phrase” with the music.

18. Pattern

By definition, a pattern is the prescribed relationship of the steps of a dance to a dance baseline. There are two types of patterns, set patterns and border patterns.

- a. In a set pattern, the steps of a dance have a prescribed relationship to the dance baseline and have certain steps required to be executed at the corners of the rink.
- b. In a border pattern, the steps of a dance have a prescribed relationship to the dance baseline without having a prescribed location on the floor.
- c. Since all border pattern dances are drawn to an endless “straight line baseline,” the beauty and challenge of these dances is to place the steps of the dance within the confines of a skating floor without changing any edges or lobes or altering the axis of the dance.
- d. There are five rules regarding border pattern dances. These rules are absolutely mandatory.
 1. **May Be Skated as a Set Pattern**
Border Pattern Dances may be skated as Set Pattern Dances without penalty, provided that in the pattern used all of the listed edges (or flats) are skated as shown in the diagram and the flow of the dance is not impaired.
 2. **Same Steps Must Cross the Baseline**
Every step that crosses the baseline on the diagram of a straight line baseline must also cross the baseline of the type that is selected. Naturally all flats must be executed on the baseline.
 3. **Straightaway Baselines Must Not Change**
Once a baseline has been established on the straightaway of the floor, that chosen baseline must be adhered to every time around. It should be initially established far enough from the barrier to allow the largest barrier lobe to be executed correctly. Thereafter, the location of that baseline must be adhered to.
 4. **The relationship of the edges being skated to the prescribed dance pattern must be maintained.** However, even though definite edges and flats are called for in border dances, they are sometimes not practical on the ends of the rink. Judges will make exceptions for changing edges from outside to inside and vice versa or changing sequences of flats to edges when necessary to traverse the ends of the rink. Skaters who plan their dance well will not have to make extreme or repetitious changes.
 5. **The Full Floor Must be Used**
Teams are mandated to cover the entire floor when skating a Border Pattern Dance. It is a serious error if a team cuts across the width of the floor while executing a barrier lobe when there is still sufficient room to do another center lobe that would start on the straightaway baseline. It is mandatory that the full skating floor be used. This is the essence of a well-skated and well-planned Border Pattern Dance.

19. Slide

By definition, a slide is a step wherein the free foot (all four wheels) is kept on the surface of the skating floor and is moved to a leading position.

20. Curtsy

By definition, a curtsy is a two-foot movement wherein the two front wheels of the trailing skate are touched to the floor directly behind and tracking the heel of the leading skate.

21. Two-Foot Turns

- a. The forward-to-backward variety of an open two-foot turn must be executed with the second step of the turn being placed heel to heel with the first step. The skates must be on a single tracing with the heels touching at the moment the second step begins.
- b. The backward-to-forward variety of an open two-foot turn must begin with the free skate starting with a progressive motion from behind the tracing skate and then taking the floor in an approximate heel to heel position.
- c. IB to OF Choctaw Turn
During a LIB to ROF-Swing Choctaw turn, both partners must rotate to an open position prior to stepping forward. The lean must change from leaning to the center to leaning towards the barrier before stepping forward on the ROF edge. If either partner is leaning in the opposite direction, it is wrong and must be penalized by the judges.
- d. Closed Mohawk Turn
During the execution of an outside forward to outside backward closed mohawk turn, the second step of the turn must take the floor in the "parallel and" position.

22. Rotation

- a. By definition rotation is a circular motion of the torso in a horizontal plane. Implicit in this definition is that the rotation must be continuous and constant.
- b. Concentric rotation is the rotation of partners at the same time around the same team posture baseline, e.g., the rotation of partners on the continuous barrier lobe of the Chase Waltz.

23. Three-Turns

- a. By definition, a 3 -turn is a one-foot turn from a forward edge to an opposite backward edge, or vice versa, with the rotation in the direction of the initial edge and with the cusp of the turn inside the circle. There are two types of 3-tums - Dropped and Held.
- b. A "Dropped" 3 -turn is one in which the concluding edge is held for no more than one beat of music, with the next step executed on the next succeeding beat of music.
- c. A "Held" 3-tum is one in which the concluding edge is held for more than one beat of music.

24. Starting and Restarting

- a. In all USARS competitions, dance teams must start from a stationary position. The opening steps must adhere to the specific requirements of each dance. The counting of musical beats for the opening steps begins with the first recognizable body movement.
- b. If it is necessary for a team to restart a dance, they are not required to do so from a stationary position. However, after restarting, the steps of the dance must be skated to the beat of the music specified in the diagram.

ARD-C SKATE DANCE POSITIONS

1. Closed or Waltz Position A:

Partners face each other directly, one skating forward while the other skates backwards. The man's right hand is placed firmly against his partner's back at her shoulder blade with elbow raised and bent sufficiently to hold her close. The woman's left hand is placed against the man's right shoulder with her arm resting comfortably on his, elbow to elbow. The man's left arm and * woman's right arm are extended at average shoulder height. The shoulders are parallel.

2. Killian or Side B Position:

Partners face in the same direction, woman at the right of the man, man's right shoulder behind woman's left. Woman's left arm is extended in front across man's body to his left hand, while his right arm is behind her back. Both right hands clasped and resting at her waist over hip bone. This position may also be reversed, with the man at the right of the woman, both hands clasped and resting at her waist over the left hip bone.

3. Tandem Position C:

Skaters positioned directly behind each other, skating identical edges. Hold can be either both hands for both skaters, on woman's waist, or one hand on woman's waist (both skaters) with the other one outstretched.

4. Foxtrot or Open D Position:

Hand and arm positions are similar to those of the Closed position, but the partners turn slightly so that both may skate in the same direction. The man's left hand and the woman's right hand lead. This position may also be reversed, with the man on the woman's right side.

5. Trailing Foxtrot or Trailing Open E:

Same as the Foxtrot or Open D, except that the clasped leading hands are reversed, following the couple rather than leading the couple.

6. Side Closed or Tango F:

Partners face in the same direction, one skating forward while the other skates backwards. Unlike the Closed A position, partners skate hip to hip, the man either to the right or left (Reversed F) of the woman.

7. Hand-in-Hand Position G:

Partners face in the same direction and are side by side with arms comfortably extended, the man's right hand in his partner's left. The woman is on the right side unless otherwise noted.

8. Crossed Arms H:

Same as the Killian B position, except that rather than being on the woman's right hip, the man's right hand is placed in front of the woman and both partners clasp hands close to the woman's torso.

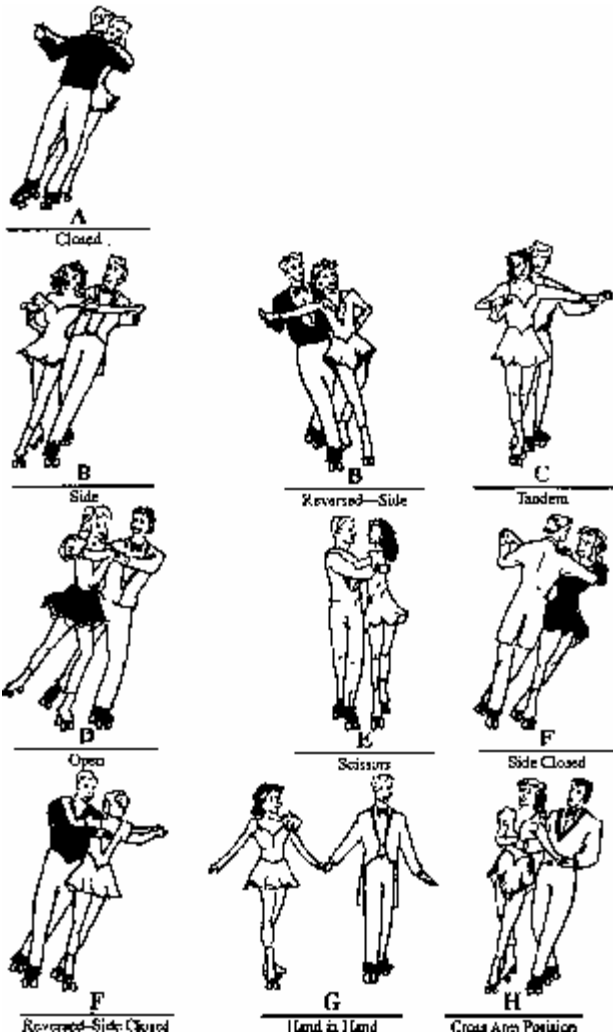

ARD-D GENERAL STANDARDS FOR DANCE SKATING

1. Standard techniques for roller skate dancing:
 - a. Carriage should be upright with a correct posture baseline.
 - b. The head should be held upright.
 - c. The rise and fall of the body should be obtained by the bending of the tracing knee.
 - d. The toe of the free leg should be turned downward and outward on all steps that are stroked. (See the definition of 'stroke'.) For those non-stroked steps, the position of the toe of the free leg is optional.
 - e. Avoid all violent or stiff movements.
2. Careful attention must be paid to the timing and rhythm of the music. Steps of the dances must be skated to the beat of the music specified in the diagrams.
3. All steps should be accurately skated. Neatness of footwork is essential
4. All edges and turns must be skated smoothly and effortlessly.
5. In Team Dance, the dance must be skated using the designated skate dancing position. Where there is a change from one position to another, the change must be made on the step called for. The method of changing positions is left up to the skaters, provided that the skaters maintain hand contact during the change.
6. Where there is a rockover between the lobes of the dance, the number one beat of the new lobe should occur slightly beyond the baseline with the point of inflection of the rockover occurring on the baseline. The end of the

last edge of the old lobe may be sacrificed so that the start of the new lobe may begin on a true and accurate edge.

7. Certain border pattern dances may be skated as set pattern dances without penalty, provided that, in the pattern used, all the listed edges or flats are skated as shown in the diagram and the flow of the dance is not impaired.
8. The pattern of the barrier lobes of any dance at the corners of the rink may be arranged proportionately to suit rink conditions. Both parts of the pattern at the corner must be symmetrical.

ARD-E NOTES ON DANCE DIAGRAMS

1. A dance diagram, if simple and concise, is of great assistance to all skaters. At a glance, these diagrams show sequences of steps, axes, edges, pattern layouts and the directions in which the steps should be aimed. The relationship of the dance diagram to the actual skating of the dance should be maintained as closely as possible for correct dance execution and musical expression.

2. Pattern

- a. The dances are diagrammed with constant curvature for each individual lobe along a reference baseline, moving around the skating surface in a counterclockwise direction. Each step is drawn so that its length represents a constant proportion to the total length of the dance pattern. Thus, a two-beat edge is twice the length of a one-beat edge and a four-beat edge is twice that of a two-beat edge.
- b. The diagrams show, as clearly as can be reduced to paper, the skating direction and depth of arc for each edge of the dance, as well as its position on the overall pattern. While the actual skating of the dance in these respects may vary somewhat from the printed diagram, this variation should not be such that the pattern and the lobes are distorted, or that edges become flats or near flats, or that the flow of the dance along the skating surface is impaired.

3. Step Identification

- a. The steps for each dance are numbered on the diagrams of easy reference. Although most dances will begin at step number 1, many dances provide an optional position for starting which may be determined from the text of the dance.
- b. The type of steps used throughout the dance is indicated alongside the diagram by means of abbreviations, which appear in the dictionary section.

4. Music

- a. The relationship of the music to the steps of the dance is shown on the diagrams by the numbers placed alongside of the tracing of each step. While the duration of each step is not shown by the number itself, this can be determined by counting the number of beats of music indicated by the number digits shown alongside the tracing of each step.
- b. The metronome tempos prescribed for the dances are official for all tests and competitions. No deviation will be permitted, so that all will skate and be judged with a uniform speed. The tempo of each dance has been set so that the utmost grace and beauty of the routine will be displayed.

5. Lobes

Center Lobe Edges	Barrier Lobe Edges
ROF	RIF
LIF	LOF
RIB	ROB
LOB	LIB

- a. Lobes which travel into the center of the dance pattern to the inside of the baseline reference point, are called center lobes and the rotation of their edges is in a clockwise direction. These lobes would make indentations on the overall dance pattern.
- b. Lobes which travel outward, toward the rink barrier, and return to the baseline are known as barrier lobes. The rotation of their edges is in the same counterclockwise direction as the general pattern of the dance. A continuous, unbroken barrier lobe traveling completely around the rink would cause the dance pattern to be either round or oval

- c. A barrier lobe will always be followed by a center lobe or vice-versa unless a flat sequence is inserted which would travel along the baseline. Flats are frequently used in the more advanced dances to lend greater variety to the lobe combinations.
- d. Dances are constructed with various sizes of lobes. In a particular dance, the size of the lobe will be determined by the number of musical beats allotted to it, thereby regulating the length of time that the employed skate will travel on the lobe.
- e. When a lobe consists of more than a single edge, all the edges that make up the lobe should conform to a constant curvature of the lobe, just as though the lobe were one continuous edge from baseline to baseline.

6. Lobe Aim

- a. The employed skate's angle, or degree of departure from the baseline, on each new lobe is referred to as the axis of the dance. Although dance axes may vary between dances, the axis of any particular dance should not change when once established on the first lobe of the dance.
- b. The term "aim," as used in dance skating, is the starting direction of all edges. An edge, originating from the baseline, must have its aim conform to the axis of the dance. All subsequent strokes on the lobe must be properly aimed to follow the general curvature of the whole lobe, maintaining a constant, even arc.
- c. When one of the eight possible skating edges originate the lobe from the baseline, it should have a fixed direction of aim. ROF, LIF, RIB, and LOB edges are only used for center lobes. Barrier lobes make use of RIF, LOF, ROB, and LIB edges only.

7. Axis of Skate Dancing

- a. The skate dances cross and recross the baseline (line of travel or "continuous axis") at certain varying angles. These angles are expressed in degrees of arc. Three different angles cover all of the present day dances: 45 degrees, 60 degrees, and 90 degrees. For example, the Fourteen Step is skated at approximately 45 degrees, the Fascination Foxtrot between 45 and 60 degrees, and the Continental Waltz at approximately 90 degrees. The axis for many of the forward skating dances can range from 45 degrees up to 90 degrees.

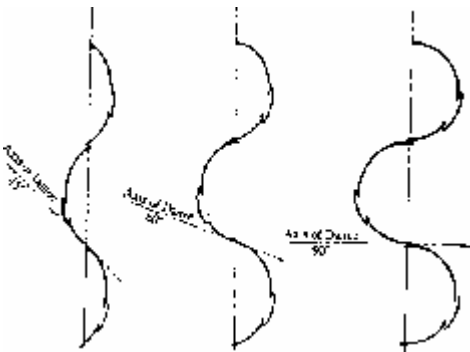

- b. The axis of a skate dance is the angle at which the lobes of the straightaway cross and recross the baseline. Partners should step in unison at the same angle when dancing.
- c. The actual axis of a dance may vary from rink to rink in order to adjust the pattern as diagrammed to suit the differences in floor sizes and shapes.
- d. The three diagrams above show the same lobes of the Glide Waltz skated at the three angles mentioned above. It is important to know and skate the correct axis for each dance because the character of the dance may be considerably altered by deepening or reducing the edge.

8. Limitations

- a. Mathematically, the second half of the lobe starts at the top or high point of the lobe, as indicated by the diagram of the dance. This is based on the assumption that the number of beats in the first half of the lobe will cover the same amount of floor as a like number of beats in the second half of the lobe. Should this assumption not be true, as in the center lobe of the Balanciaga, the distribution of the number of beats on

each half of the lobe must be modified. It is more correct to adhere to the baseline than it is to have the lobe mathematically divided in halves by the number of beats and fail to return to the baseline.

- b. In the interest of clarity, the diagrams have been kept as simple as possible. Changes of sides and positions, where one skater rotates around to the other side of the partner or to get ahead of the other partner, are sometimes omitted.
- c. Factors that cannot be diagramed include style, carriage, rhythm, footwork and interpretation.

ARD-F MUSIC FOR DANCE SKATING

Fred Autenrieth, SRSTA and Chester H. Curry, M.A., Music Education

I. A Short History of Music

- a. Rhythm is always with us. We walk in a sort of rhythm. We talk rhythmically. When we tap our feet or fingers, we are producing a rhythm.
- b. The metronome gives us the most simple rhythm obtainable - a regular pattern of equally accented beats in tempo. Your heart or pulse is similar.
- c. When dancing to melodies became popular and measures became an important part of music, the number of beats in a measure were varied to suit the type of dance. Today we have many types of dances which have evolved throughout the years and which convey various human emotions.

2. The Purpose of Music in Skate Dancing

- a. Music has basically one purpose in skate dancing: to provide the skater with a metered rhythm by which the skater can allot the proper amount of time to each step of a dance. This includes, of course, the proper placement of one-foot turns within any given step.
- b. In order for the skater may understand this function of music, it is necessary to define and clarify several musical terms as they apply to skate dancing.

(1) Beat: The regular, recurring and periodic pulse or throb that constitutes the unit of measurement in all measured music.

(2) Metronome: The mechanical device used by the musician to establish a consistent beat. This instrument is adjusted to produce, either visibly or audibly, a given number of beats per minute, the duration of time between all beats being exactly equal. For example, at 60 beats per minute, there would be exactly one second from the beginning of any beat to the beginning of the next beat.

All beats produced by a metronome are equal in heaviness or loudness - no beat is emphasized or accented. In music, however, there are three types of beats, classified according to the amount of accent:

- | | | |
|----------------|----------------|----------|
| 1. Strong Beat | (heavy accent) | marked |
| 2. Weak Beat | (light accent) | marked > |
| 3. Off Beat | (not accented) | no mark |

(3) Rhythm: Usually a pattern of weak and off beats which gives each type of music its own flavor. While the rhythm also includes strong beats, it is primarily the weaker beats which lend a characteristic rhythm pattern to each type of music.

(4) Melody: The tune or "song."

- c. Before examining any further terms, let us see how beat, rhythm and melody apply to skate dancing. Each step of a dance begins on a beat of music. There are no exceptions. Therefore, it is extremely important that the skater be able to hear the beats which are generally the low sounding notes played by the foot pedals of an organ or by the string bass, bass guitar and/or bass drum in a band. The majority of dance steps occur on strong beats, some occurring on weak beats and a few on off beats.
- d. The rhythm usually determines the placement of one-foot turns within a given step of a dance. In general, the rhythm is played by an organist's left hand on the lower of two sets of keys (lower manual) or by the piano, trombones, baritone saxophone, snare drums, cymbals or rhythm guitar in a band.

- e. The melody line is relatively unimportant in skate dancing except for one thing - at the beginning of the melody in many songs there occurs "pick-up" or "lead-in" notes which are part of the melody. These must be regarded as part of the introduction to the song for skating purposes. They are almost always played without accompaniment of rhythm or beat. The melody is normally played on the upper manual of an organ or by the trumpets, alto and tenor saxophones, sometimes the trombones, or lead guitar in a band.
 - f. Thus, the beat is generally made up of low notes and provides the timing for the steps of a dance. The rhythm consists of middle register notes and locates one-foot turns within a dance step. The melody is made up of upper range or high sounds and should be mainly disregarded with respect to proper timing in skate dancing.
 - g. Other music terms important in skate dancing are:
 - (1) **Measure or Bar:** A group of beats. All measures in a given type of music contain the same number of beats.
 - (2) **Phrase:** A group of measures. Typically, a musical phrase is made up of four measures of music. For skating purposes, all phrases begin on a strong beat.
 - (3) **Tempo:** Speed of music; the number of beats per minute. This is expressed in terms of a metronome; e.g., 92 metronome equals 92 beats per minutes as set by a metronome.
3. Time Signatures in Music
- a. Each type of music has what is known as a time signature. This appears in the form of a fraction printed on the sheet of music to be played. For skate dancing purposes, only four different time signatures are used- 2/4, 3/4, 4/4 and 6/8. The top number indicates the number of beats in a measure The lower number, while unimportant to the skater, tells the musician what kind of note gets one beat.
 - b. The 6/8 time signature is used only in march music and, therefore, may be a little confusing. Technically, there are six beats in a measure of 6/8 march music. For skating purposes, however, the music is played at 300 beats per minute with the first beat of each measure strong, the fourth beat weak, and beats 2, 3, 5 and 6 as off beats. The effect of this is that the music sounds like 100 beats per minute with only two beats per measure, the first beat sounding strong and second beat weak.
 - c. 2/4 music is used for polkas and some marches. Here there are two beats per measure and usually four measures per phrase.
 - d. 3/4 music is used for all waltzes. In 3/4 music there are three beats per measure and normally four measures per phrase. In some waltzes, such as "The Drinking Song" from "The Student Prince," the phrases are made up of eight measures.
 - e. All foxtrots, schottisches, blues, boogies and tangos are 4/4 music. Each type has four beats to a measure and, typically, four measures to a phrase.
 - f. The General Make-up of Music
 Music is wholly made up of notes and rests. For each type of note there is a corresponding type of rest. All notes and rests are written on a musical "staff" of five lines. Vertical lines indicate measures with everything between two vertical lines equal to one measure. The four main types of notes and rests are:
 - (1) Whole note, written

Whole rest, written
 - (2) Half note, written

Half rest, written

(3) Quarter note, written

Quarter rest, written

(4) Eighth note, written

Eighth rest, written

- g. Whether speaking of notes or rests, two eighths equal one quarter, two quarters equal one half, two halves equal one whole. Any combination of eighths, quarters and halves may be used to make up a whole note so long as the total equals four beats (the normal value of the whole note).
- h. It was stated earlier that the lower number in a time signature tells what kind of note gets one beat. In skate dancing music only the numbers 4 and 8 appear in the lower position. Therefore, only quarter and eighth notes (or rests) get one count. And, as was previously explained, the six eighth notes in 6/8 time are speeded up to sound like two-quarter notes, each subdivided into three equal parts.
- i. Notes may be tied together and their values thus accumulated. Thus:
- j. One group of notes, which does not fit the normal value definition, is the so-called “triplet-eighth” group. This is written and counted:
- k. With these things in mind, let us look at a one-line illustration of melody, rhythm and beat for a typical waltz.
- l. Notice that the beat and rhythm lines fit to sound like one line and that the rhythm line provides beats #2 and #3.

Examine now a typical 4/4 selection.

Melody 4/4
Rhythm 4/4
Beat 4/4

- m. There are many variations of these two basic patterns, but all can be essentially identified as one of the above. Even the syncopated rhythm of the tango or the bounce of a boogie can be reduced to the basic 4/4 pattern.

4. Counting Music

- a. In order that the skater may allot the proper amount of time to each step of a dance, the skater must be able to “count” the music. Since all steps begin on a beat of music, it follows that all steps include a given number of whole beats. Therefore, the skater must identify and count the beats of the music in order to properly skate any dance.
- b. By learning to count the beats and rhythm lines, the skater can follow any type of music. Remember that in almost every case, beat # 1 of a measure in all types of music will be heavily accented, and in 4/4 music, beat #3 will normally be lightly accented to produce an audible rhythm pattern to follow.

5. Skating “In Phrase” with Music

- a. The first beat of music after the introduction to any song begins a skating phrase. To skate “in phrase” with the music, the skater must start his opening steps either on the first beat or on the first beat of an odd-numbered measure following measure number one. In addition, the opening steps should take up an even number of measures.

- b. To be perfectly certain of skating in phrase, the skater should start his opening steps on beat number one of measure one, five or nine, etc. and use four measures of music for the opening steps. It should be noted, however, that in most cases, two-measure groups will be correct. The melody line determines the phrasing of the music. Most "standard" popular songs, many of which are used for skate dancing, are made up of four groups of eight measures. The melody is generally played once during the first eight measures and repeated during the second eight measures. The third eight bars constitute the "bridge" or correcting sequence, and the last eight bars are usually a third repetition of the melody.
- c. Each eight-measure sequence is usually divided into two four-measure phrases. (Although there may be four two-measure phrases.) If the skater has a good "ear" for melody, he should be able to begin a dance in the middle of a song without difficulty. The only problem would be that of pickup notes which occur before beat #1 of an odd-numbered measure.
- d. A notable and common exception to the 32-bar popular song is the so-called 12-bar blues. This type of music is made up of three groups of four measures and is generally played for the Dench Blues and others. By beginning the dance in beat #1 of measure 1, 5 or 9, the skater is assured of being in phrase with blues music.
- e. This article is not intended to be a complete course in music, but it should be helpful in understanding the relationship between the music and the dances being skated.

ARD-G ORIGINAL DANCE (OD)

For rules pertaining to the Original Dance portion of Junior and Senior World Class Dance, refer to Rule AR11.04.04.

ARD-H FREE DANCE

For rules pertaining to the Free Dance portion of Junior and Senior World Class Dance, refer to Rule AR11.04.05.

FREE SKATING

ARFS-A GENERAL

The basic movements in a free skating program consist of jumps, spins and footwork, which are blended, in harmony with the skater's choice of music. Free skating permits complete freedom as to the style, content and music used in the composition. Skaters are not restrained by prescribed routines or patterns as exist in figure and dance skating.

Free skating performances should be skated in an interpretive manner so as to capture the tempo and mood of the chosen music. Where good form is maintained at all times throughout the routine, an impression is projected of complete program mastery. The speed and height of the jumps, the control and velocity of the spins, and the individuality and sureness of the footwork gauge the quality of the performance.

Presentation and "showmanship" are important in the achievement of the proper program effect as well. In the selection of costuming, for example, care should be taken to complement the routine in a visually pleasing manner, and yet not detract from the skater's performance as a whole.

Free skating, where the proper balance of performance and degree of program content exists, is considered by many to be the most spectacular and exciting form of this sport.

ARFS-B ELEMENTS IN A FREE SKATING PROGRAM

Free skating is marked: (a) for the contents performed in the routine (the mark for Technical Merit)-its difficulty, variety, and harmonious composition; and (b) for the manner in which it is performed (the mark for Artistic Impression)-its form and interpretation.

I. Content Of Program (Technical Merit)

Free skating programs should contain jumps, spins, and footwork. These are each of equal importance. There should also be "variety moves" contained in the program, graceful, but out-of-the-ordinary, such as spirals, pivots, eagles, and points made to show originality.

a. Difficulty

In competition, relative standards of difficulty should be applied to the program as a whole and not merely to obvious high-spots. This would include jumps with many rotations (performed singly or in combination) and certain varieties of spins (performed singly or in combination). A program so planned as to permit the skater to gather speed without visible effort (through dance steps, etc.) should be given a higher mark for difficulty than a similar program which employs extreme pushing movements. A program in which transitions are smooth and harmonious should receive higher grades for difficulty than a similar program in which transitions are forceful.

b. Music

A program planned to music should receive a higher rating for difficulty than a similar program to which the music is just background. Difficulty will not only be disregarded where attempted moves are obviously beyond the skater's ability, but will be penalized by the judges in the score given for Technical Merit.

c. Variety

Variety should cover more than the use of different figures, dances, spirals, etc. It should also include changes of pace, changes of lean and edges, changes of rhythm and accent on the beat of the music, as well as surprise moves, which happen unexpectedly.

d. Harmonious Composition

Programs should cover the whole skating surface. Successive parts of the program should be linked together logically and smoothly. The program should not have the impression of being a succession of isolated tricks and moves. The program should also be kept within the barriers of the rink. Judges will penalize running into a rail or wall the same as if it were a fall.

2. Manner of Performance (Artistic Impression)

The following program essentials, form and interpretation, must be considered when arriving at a Manner of Performance (Artistic Impression) score for a singles routine.

a. Form

Carriage, flow and motion, reflecting smoothness and ease of performance while jumping, spinning and the skating of footwork:

- The general body position, except in planned positions should be erect but not stiff.
- The free leg should be carried as gracefully as possible, extended wherever possible, and controlled without stiffness. It should move freely and easily to assist movement, but at all times with control.
- The skating knee should always be used with great flexibility, continually straightening and bending to give the easy glide (flow) and effortless run that is the basis of skating.
- The head should be erect and in most cases high and in line with the back. The neck should be kept up away from the shoulders. The arms should be extended, and when moved, held in a graceful position. Hyper-extension should be avoided.
- The hands should follow the line of the arms, not being allowed to droop, dangle, or curve in an affected manner.
- The fingers should be held easily, not clenched or rigid.
- Speed should be gained and maintained as easily as possible, normally without bending at the waist.
- In general, everything violent, angular, or stiff should be avoided. There should be no visible strain and the impression should be given that the entire program is effortless and executed with ease.

b. Interpretation

This is the individual's interpretation of the rhythm, tempo and mood of the program's music. Movements of the routine should be arranged to conform and harmonize with the musical pattern. The skater's "showmanship" is displayed by a projection of ease, accomplishment and confidence. Stereotyped body and arm positions, which are lacking in originality and individuality, should be avoided, along with affected attitudes.

ARFS-C PERFORMANCE VALUES

1. **Manner of Performance (Artistic Impression)** is equal in value to Content of Program (Technical Merit). Consideration for these components is a matter of serious importance in that it demonstrates the craftsmanship, the degree of competence and the skill that is present in the skater.
2. **Content**
Full credit should be awarded for items of content only when they are executed gracefully, with clean and firm entrances and exits. This is not to say that a wobbly jump or spin is completely without value, but should be recognized as being considerably less meritorious than a bold and firm handling of the same content item. Further credit should be assigned to items that are skated with a degree of spontaneity and a measure of originality.
3. **Creative footwork** is always present in a quality skating performance. The redundant use of "cross pulls" and other plain strokes as linkage between jumps and spins is undesirable, boring, and distracting in the routine, and should result in a lower grade given for such performance. Content items should be linked together with varied and interesting connecting movements as well.
4. No free skating performance is complete until the skater demonstrates his or her ability to roller skate. This is the province of "footwork" in the routine and will add an element to the skating performance that jumps and spins alone will not provide. Footwork pulls the routine together and blends the major content items into a skating performance where otherwise they would be simply a collection of free skating movements.
5. Selection of the musical accompaniment in a free skating program is very important. The age of the skater is not necessarily the criteria that dictates the musical selection, rather it should be compatible with the skater's personality, energy, image, strength, ability, and level of proficiency and maturity. Once the music is selected and fits the skater, choreography of the routine must integrate body motion, rhythm, and harmony in the skater's interpretation and presentation.
6. A change of pace and a variety of moods is desirable in any well-planned free skating routine. This is often accomplished by blending different pieces of music together, known as "cuts." Although there is no limit to the amount of cuts used, great care should be taken in the transitions from one piece to another to insure a pleasing, harmonious blend. Abrupt or erratic changes in mood and extremes in musical styles within the same program should be avoided. When the music is disjointed, the skater's performance will appear fragmented.
7. Free skating performances can rise to artistic levels which compare favorably with all media of musical expression, on skates or off. When one witnesses this caliber of skating by a fine singles skater, it becomes a thrilling experience. Our appreciation is often a mixture of admiration for the craftsmanship of the skillful skating

technician and a reflection of the combined beauty of music, line and movement displayed in the skating performance.

ARFS-D JUMPS

1. A jump is a movement, involving a turn or turns, which carries the entire body and skates off the skating surface. A leap or hop has a similar definition except it does not involve rotation of any kind.
2. Jumping can be described as an attempt on the part of the skater to defy the “laws of gravity.” The three dimensions of jumping are: momentum, height, and travel. Momentum refers specifically to the speed of the skating which immediately precedes the jump; height has reference to the amount of elevation at the apex of the jump; and travel refers to the amount of distance between take-off and landing.
3. It is possible to perform all jumps by rotation in either a clockwise or counterclockwise direction. It is important to note that in the final analysis of a jump, rotational direction is not a consideration.
4. Jumps, leaps, and hops may be performed in any of a variety of positions while the skater is airborne. Some of these positions readily lend themselves to certain jumps, such as a Split or Stag during a Half Flip, and a Mazurka during a Half Mapes. Descriptions of varied jumping positions are listed in the section under “Variations to Standard Jumps.”
5. Evaluation of any jump, however, should be based on its three component parts: take-off, flight, and landing. In the analysis of each of these component parts of a jump, thorough consideration should always be given to: (a) the three dimensions of jumping (momentum, height, and travel); (b) the take-off and landing edges; (c) the number of rotations in the air; (d) body positions; and, (e) sureness and control.

a. Three Dimensions of A Jump (Momentum, Height, And Travel)

The questions “how fast?”, “how high?”, and “how far?” should be answered when evaluating each jump in a routine. Degree of Difficulty of a particular jump is related proportionately to the level in which these factors are involved.

b. Take-Off and Landing Edges

Any jump which does not conform to the listed take-off and landing edges as noted in the description of the jump does not qualify as the listed jump.

Take-off and landing edges should be clean and not cheated, that is, performed incorrectly while having the false appearance of correctness.

c. Number of Rotations In The Air

Certainly, as the number of rotations in a jump increases, the level of difficulty increases proportionately. However, it should be noted that if the increased rotations are insufficient and under-rotated so as to cause hooked or pulled take-offs and/or landings (or cheated in any way), less credit should be given for both Content of Program (Technical Merit) and Manner of Performance (Artistic Impression).

d. Body Positions

Body positions on take-offs, flights, and landings are optional within the realm of good form. However, for leg positions during airborne rotation, considerably more credit should be given for a “low-wrap” (the legs or feet crossed below the knees) than for a “high-wrap” (the free foot rising above the knee). Also, during flight, the axis of the body (posture baseline of rotation) should be in a straight line and relatively vertical to the skating surface.

On standard OB landings, the free leg should be in front at the moment of the landing and then drawn through to the full, extended-back position. In all cases, there should not be violent, angular, or stiff movements, which impede the flow of the jump. It should also be recognized that positions, which are out-of-the-ordinary, but visually pleasing and musically interpretive, have a degree of difficulty greater than that of standard positions.

e. Sureness and Control

Any skater showing obvious strain or effort while performing jumps in a free skating program, or lacking the control necessary to complete the attempted items should be penalized accordingly in both Content of Program (Technical Merit) and Manner of Performance (Artistic Impression).

6. Use of the Toe-Stops on Jumps

From a judging standpoint, it should be understood that the toe-stop should never be used to deliberately slow down the momentum of the skater for the entry of a jump. However, in many cases, the toe-stop is used to aid the take-off and/or landing of a recognized jump. For the sake of clarity in the following descriptions, the term “toe-plant” refers to the correct use of the toe-stop of the unemployed skate in the take-off and/or landing of a jump, according to the official description of that jump. The term “toe-stop assist” refers to the use of the toe-stop of the employed skate in the take-off and/or landing of a jump. The toe-stop assist should never be used in a take-off or landing and should be penalized in the scores given for Content of Program (Technical Merit) and Manner of Performance (Artistic Impression).

7. Jumps Classified

Example of Jump Diagram:

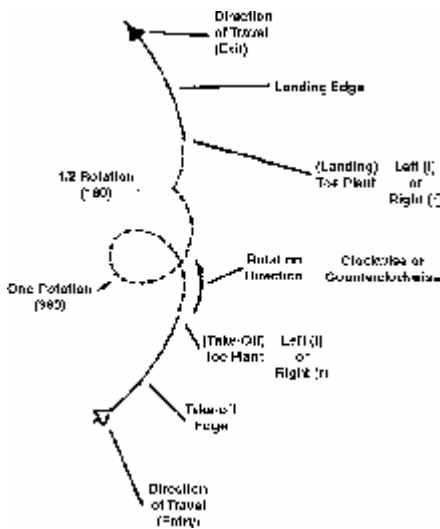

JUMP	counterclockwise rotation
l 1/2 Mapes	Take-Off Landing
	ROB (l)....(r) LOF

a. LEAPS AND HOPS (Jumps without Rotation)

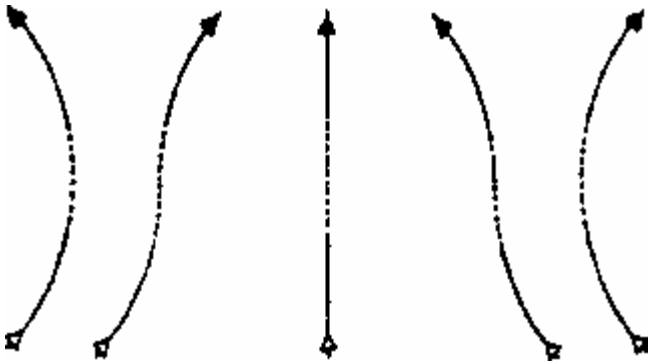

Jump Take-Off Landing..... Take-Off Landing

Forward Leap LF RF RF LF
 LF to RF or vice versa. No edges required but may be done on edges.

Bunny Hop LF (r) LF RF (l) RF
 LF to LF (with right toe-plant) or vice versa. No edges required but may be done on edges. Swing free leg forward on take-off. Toe-stop of free foot takes surface slightly ahead or alongside of landing foot.

Toe Bunny Hop RF (l) (r) LF LF (r) (l) RF
 Start on RF. Left foot extends in front. Simultaneously slide right foot forward and plant left toe-stop. Jump off left toe-stop with right foot extended forward in the air. Land on right toe-stop, pushing onto LF. No edges required but may be done on edges. Can be done vice versa.

Double Bunny Hop LF (l) RF RF (r) LF
 Start on LF. Swing right free leg forward and jump at the same time. Scissor left foot forward and land on left toe-stop pushing onto RF. No edges required but may be done on edges. Can be done vice versa.

Backward Leap RB LB LB RB
 Same as a Forward Leap except movement is backward.

Back Bunny Hop RB (l) RB LB (r) LB
 Same as a Bunny Hop except movement is backward. Swing free leg backward on take-off. Toe-stop of free foot takes surface slightly behind or alongside of landing foot.

Back Toe Bunny Hop RB (l) (r) LB LB (r) (l) RB
 Same as a Toe Bunny Hop except movement is backward. Start on RB. Left foot extends in back. Simultaneously slide right foot backward and plant left toe-stop. Jump off left toe-stop with right foot extended backward in the air. Land on right toe-stop, pushing onto LB. No edges required but may be done on edges. Can be done vice versa.

b. HALF TURN JUMPS

Half Turn Jumps are performed either on one foot only (One Foot Jumps), or from one foot to the other (Two Foot Jumps). Generally, most of the Half Turn Jumps can be used as parts of sequences of footwork.

One Foot Jumps

One Foot Half Turn Jumps - All the one-foot turns (3's, Brackets, Counters and Rockers) may be jumped. There are 16 that rotate counterclockwise and 16 that rotate clockwise.

Two-Foot Jumps

(1) Mohawk Jumps - All the Mohawk turns may be jumped. The right to left Mohawk jumps is rotated counterclockwise while the left to right are rotated clockwise. The forward Mohawks are often crossed in front on the landings, called "cut-offs."

- (2) Choctaw Jumps - All the Choctaw turns may be jumped. The right to left Choctaw jumps is rotated counterclockwise while the left to right are rotated clockwise. The forward Choctaw jumps may be crossed in front on the landings, called "cut-offs."

Generally, the more common Half Turn Jumps begin with the same take-off edges (and toe-plants) as the recognized Full Turn Jumps. The only exceptions being a half rotation in the air and a forward landing with a toe-plant of the free foot. The landing edges of these jumps are optional as noted in the descriptions, with either method being equally correct.

**Half Turn Jumps
(180 degree Rotation)**

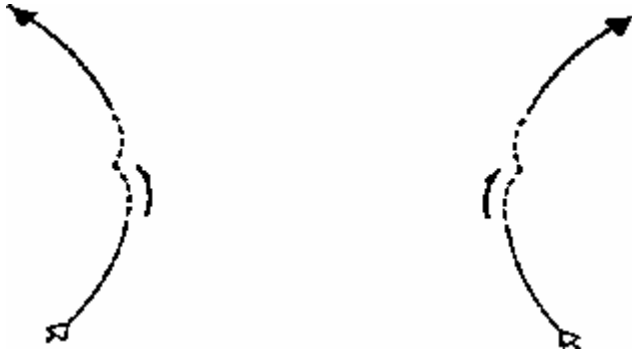

Jump	Counterclockwise	Clockwise	Take-Off	Landing
	Rotation	Rotation		
Three Jumps	LOF LIB RIF ROB LIB LOF ROB RIF	ROF RIB LIF LOB RIB ROF LOB LIF		

Mohawk Jumps	RIF LIB ROB LOF	LIF RIB LOB ROF		
---------------------	--------------------------------	--------------------------------	--	--

Waltz Jump	LOF ROB	ROF LOB		
-------------------	---------------	---------------	--	--

The Waltz Jump is from LOF to ROB or from ROF to LOB. Use the free leg for lift. Land with the free leg in front of the body with follow-thru to the extended-back landing position.

Half Loop	ROB (l) RIF	LOB (r) LIF		
	ROB (r) LOF	LOB (l) ROF		

The use of a toe-stop assist on the take-off is incorrect. The listed landing edges are optional.

Half Mapes	ROB (l) (l) RIF	LOB (r) (r) LIF		
	ROB (l) (r) LOF	LOB (r) (l) ROF		

The only difference between a Half Mapes and a Half Toe Walley is the take-off edge and entry lean. The listed landing edges are optional.

Half Salchow	LIB (l) RIF	RIB (r) LIF		
	LIB (r) LOF	RIB (l) ROF		

The use of a toe-stop assist on the take-off is incorrect. The listed landing edges are optional.

Half Flip	LIB (r) (l) RIF	RIB (l) (r) LIF		
	LIB (r) (r) LOF	RIB (l) (l) ROF		

The only difference between a Half Flip and a Half Lutz is the take-off edge and entry lean. The listed landing edges are optional.

**Half Turn Jumps
(180 degree Rotation)**

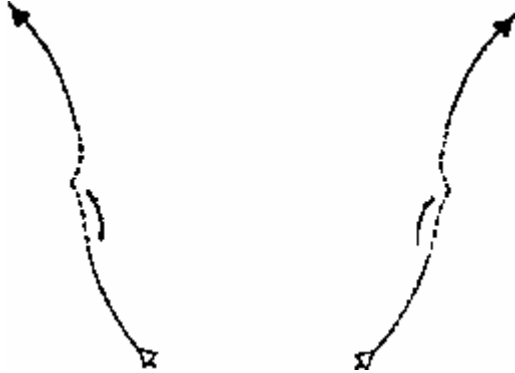

	Counterclockwise Rotation	Clockwise Rotation
Jump	Take-Off	Landing..... Take-Off
Counter Jumps	ROF.....ROB LIF.....LIB LOB.....LOF RIB.....RIF	LOF.....LOB RIF.....RIB ROB.....ROF LIB.....LIF

Choctaw Jumps	ROF.....LIB RIB.....LOF	LOF.....RIB LIB.....ROF
----------------------	----------------------------	----------------------------

Half Walley	RIB.....(l) RIF RIB.....(r) LOF	LIB.....(r) LIF LIB.....(l) ROF
--------------------	------------------------------------	------------------------------------

The use of a toe-stop assist on the take-off is incorrect. The listed landing edges are optional.

Half Toe Walley	RIB.(l).....(l) RIF RIB.(l).....(r) LOF	LIB (r).....(r) LIF LIB (r).....(l) ROF
------------------------	--	--

The only difference between a Half Toe Walley and a Half Mapes is the take-off edge and entry lean. The listed landing edges are optional.

Half Dayney	LOB.....(l) RIF LOB.....(r) LOF	ROB.....(r) LIF ROB.....(l) ROF
--------------------	------------------------------------	------------------------------------

The use of a toe-stop assist on the take-off is incorrect. The listed landing edges are optional.

Half Lutz	LOB (r).....(l) RIF LOB (r).....(r) LOF	ROB (l).....(r) LIF ROB (l).....(l) ROF
------------------	--	--

The only difference between a Half Lutz and a Half Flip is the take-off edge and entry lean. The listed landing edges are optional.

**Half Turn Jumps
(180 degree Rotation)**



	Counterclockwise	Clockwise		
	Rotation	Rotation		
Jump	Take-Off	Landing.....	Take-Off	Landing
Bracket Jumps	ROF.....RIB	LOF.....LIB		
	LIF.....LOB	RIF.....ROB		
	LOB.....*(r) LIF	ROB.....*(l) RIF		
	RIB.....*(l) ROFLIB*(r) LOF		

Mohawk Jumps	ROF.....LOB	LOF.....ROB		
	RIB.....*(r) LIF	LIB.....*(l) RIF		

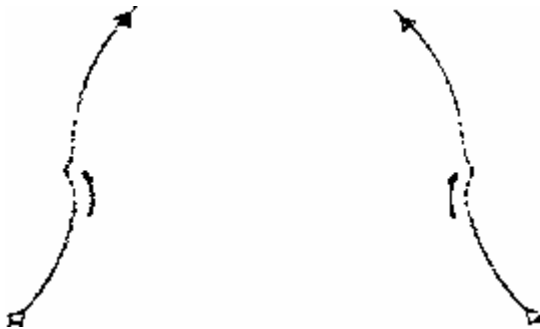

Jump	Take-Off	Landing.....	Take-Off	Landing
Rocker Jumps	LOF.....LOB	ROF.....ROB		
	LOF.....RIB	LIF.....LIB		
	ROB.....*(l) ROFLOB*(r) LOF		
	LIB.....*(r) LIF	RIB.....*(l) RIF		

Choctaw Jumps	RIF.....LOB	LIF.....ROB		
	ROB.....*(r) LIF	LOB.....*(l) RIF		

*The toe-plant landings for jumps marked with an asterisk are optional.

c. FULL TURN JUMPS - SINGLES, DOUBLES, TRIPLES AND QUADRUPLES

Many of the Full Turn Jumps are named for the skaters who originated and first executed the jumps (Mapes, Salchow, Pat Lowe, Axel, Boeckl, etc.). In recognition of this unique accomplishment, their names are perpetuated in skating posterity and mentioned daily in the skating world.

All Single Jumps may be made into Doubles by adding a full rotation in the air. The most common are the Double Salchow, Double Flip, Double Lutz, Double Mapes, Double Toe Walley, and Double Loop.

Double, Triple, and Quadruple Turn Jumps are not diagramed since they are the same take-off and landing edges as the Full Turn Jumps, with the only exception being added rotations in the air.

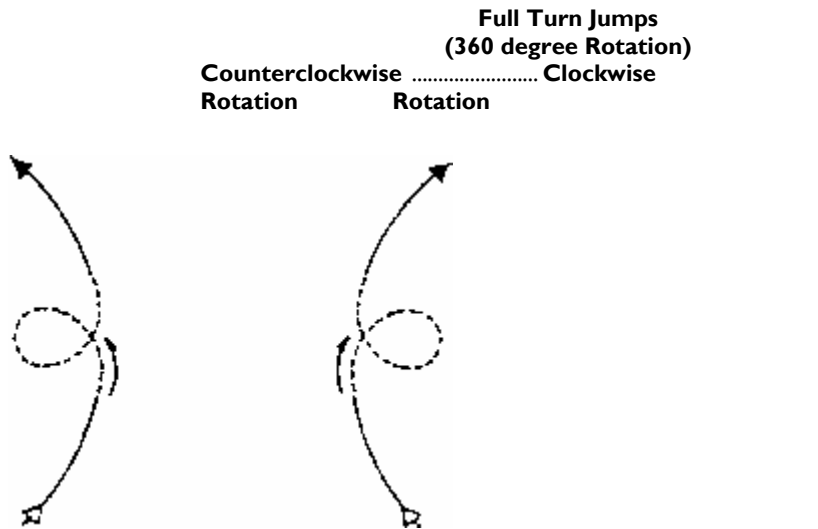

Jump	Take-Off	Landing.....	Take-Off	Landing
Euler	ROB	LIB	LOB.....	RIB
Often called a Loop Step. Use of a toe-stop assist in jumping is incorrect.				
Loop Jumps	LOF	LOF	ROF.....	ROF
	LOF	(r) LOF	ROF.....	(l) ROF
	RIF.....	RIF	LIF.....	LIF
	RIF.....	(l) RIF	LIF.....	(r) LIF
	LIB.....	LIB	RIB.....	RIB
	ROB	ROB	LOB.....	LOB

Use of a toe-stop assist in jumping is incorrect. The toe-plant landings are optional on the forward landing jumps.

Mapes ROB (l)ROB LOB (r) LOB
A Loop Jump with a toe-plant. Often called a Toe Loop. Stepping forward onto the toe-stop into the direction of travel during the take-off, or “turning open” is incorrect. Execution of a Mapes in this manner is technically a Toe Waltz Jump and considerably less credit should be given in the score for Content of Program (Technical Merit) and Manner of Performance Artistic Impression).

Salchow LIB.....ROB RIB..... LOB
Use of a toe-stop assist in jumping is incorrect.

Flip LIB (r).....ROB RIB (l)..... LOB
Similar to a Lutz except for the take-off edge and entry lean.

**Full Turn Jumps
(360 degree Rotation)**
Counterclockwise Clockwise
Rotation Rotation

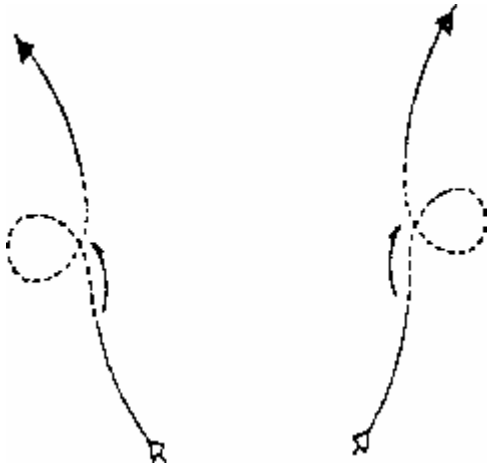

Jump Take-Off Landing..... Take-Off Landing

Pat Lowe RIB.....LIB LIB.....RIB
 Similar to a Euler except for the take-off edge. Use of a toe-stop assist in jumping is incorrect.

Walley RIB.....ROB LIB.....LOB
 Similar to an OB Loop except for the take-off edge. Use of a toe-stop assist in jumping is incorrect.

Toe Walley RIB.(l).....ROB LIB (r).....LOB
 Similar to a Mapes except for the take-off edge and entry lean. Stepping forward onto the toe-stop into the direction of travel during the take-off, or "turning open" is incorrect. Execution of a Toe Walley in this manner should be given considerably less credit in the score for Content of Program (Technical Merit) and Manner of Performance (Artistic Impression).

Dayney LOB.....ROB ROB.....LOB
 Often called a Toeless Lutz. Similar to a Salchow except for the take-off edge and entry lean. Use of a toe-stop assist in jumping is incorrect.

Lutz LOB (r)....ROB ROB (l).....LOB
 Similar to a Flip except for the take-off edge and entry lean.

e. TURN-AND-ONE-HALF JUMPS - 1 1/2, 2 1/2, 3 1/2 TURNS

- (1) Most of the Full Turn Jumps may be extended into 1 1/2 Turn Jumps by adding a 1/2 rotation in the air, landing on the toe-stop (toe-plant) and pushing onto the other skate. The Loop, Salchow, Mapes, Flip, and Lutz all make good 1 1/2 Turn Jumps. The skater should strive for 1 1/2 turns in the air. It is incorrect to rotate only a single turn in the air, landing backward, with a 1/2 turn rotation on the toe-stop before stepping forward.

In rare cases, it is possible that skaters will attempt to perform 2 1/2 Turn Jumps with toe-stop forward landings. We will not diagram these items since they would be the same as the 1 1/2 Turn Jumps with another rotation added.

- (a) **Axel** - Although this jump has 1 1/2 turns in the air, it is commonly known as a Single Axel. With 2 1/2 turns in the air, it is called a Double Axel, and with 3 1/2 turns in the air, it is called a Triple Axel-and so on.

- (b) **Boeckl** - Like the Axel, this jump has 1 1/2 turns in the air, and is commonly known as a Single Boeckl. With 2 1/2 turns in the air, it is called a Double Boeckl, and with 3 1/2 turns in the air, it is called a Triple Boeckl-and so on.

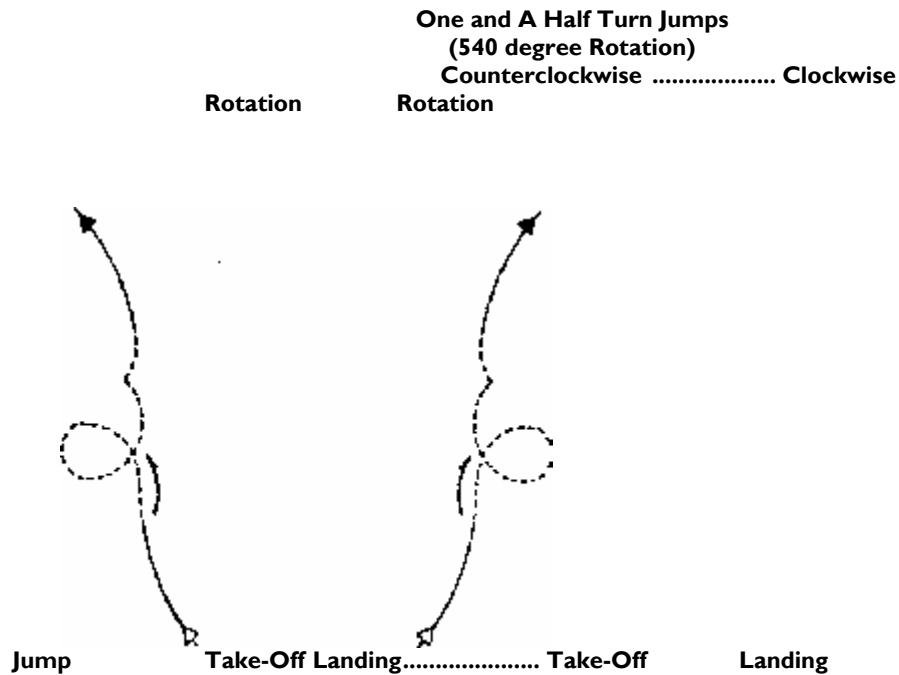

Axel LOF ROB ROF..... LOB

Colledge LOF LIB ROF..... RIB

Boeckl RIF..... ROB LIF..... LOB

Boeckay RIF..... LIB LIF..... RIB

1 1/2 Loop ROB (r) LOF LOB..... (l) ROF
The use of a toe-stop assist on the take-off is incorrect.

1 1/2 Mapes ROB (l) (r) LOFLOB (r)..... (l) ROF
Stepping forward onto the toe-stop into the direction of travel during the take-off, or “turning open” is incorrect. Execution of a 1 1/2 Mapes in this manner should be given considerably less credit in the score for Content of Program (Technical Merit) and Manner of Performance (Artistic Impression).

1 1/2 Salchow LIB..... (r) LOF RIB..... (l) ROF
The use of a toe-stop assist on the take-off is incorrect.

1 1/2 Flip LIB (r)..... (r) LOF RIB (l)..... (l) ROF
Similar to a 1 1/2 Lutz except for the take-off edge and entry lean.

**One and A Half Turn Jumps
(540 degree Rotation)**

**Counterclockwise Clockwise
Rotation Rotation**

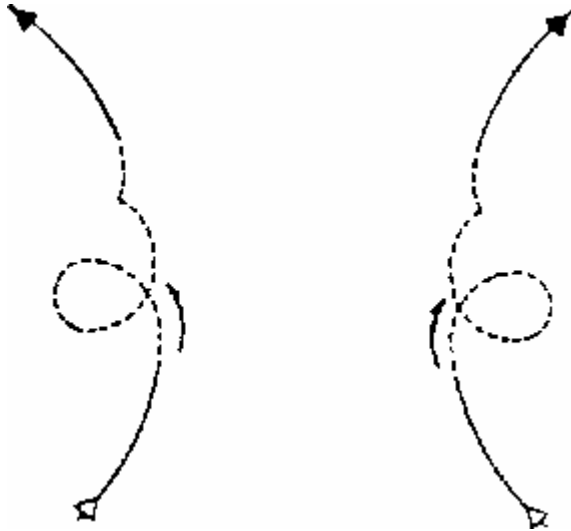

Jump Take-Off Landing..... Take-Off Landing

1 1/2 Walley RIB.....(r) LOF LIB (l) ROF
Similar to a 1 1/2 Loop except for the take-off edge. Use of a toe-stop assist on the take-off is incorrect.

1 1/2 Toe Walley RIB (l).....(r) LOF LIB(r) (l) ROF
Similar to a 1 1/2 Mapes except for the take-off edge and entry lean. Stepping forward onto the toe-stop into the direction of travel during the take-off, or “turning open” is incorrect. Execution of a 1 1/2 Toe Walley in this manner should be given considerably less credit in the score for Content of Program (Technical Merit) and Manner of Performance (Artistic Impression).

1 1/2 Dayney LOB.....(r) LOF ROB (l) ROF
Similar to a 1 1/2 Salchow except for the take-off edge and entry lean. Use of a toe-stop assist on the take-off is incorrect.

1 1/2 Lutz LOB (r).....(r) LOF ROB (l)..... (l) ROF
Similar to a 1 1/2 Flip except for the take-off edge and entry lean.

f. COMBINATION JUMPS

A Combination is an item that contains a succession of jumps (2 or more) in which the landing edge of each jump is the take-off edge of the following jump. If a turn, change-of-edge, footwork, or other item is between the jumps, it is not classified as a Combination.

Examples:

- 2-Way Combination: Boeckay-Double Flip
- 3-Way Combination: Double Lutz-Euler-Double Flip
- 4-Way Combination: Axel-Loop-Euler-Double Salchow
- 5-Way Combination: Waltz Jump-Loop-Mapes-Euler-Salchow

g. JUMP SERIES

A Jump Series is similar in appearance to a Combination with the exception that turns, changes-of-edge; footwork, or other items are performed between any of the jumps. Generally speaking, a Jump Series has a lesser degree of difficulty than a Combination that contains an equal number of jumps. There are exceptions, however, and should be recognized if performed well.

Examples:

- Jump Series: Boeckl, 3-Turn, Boeckl

4-Way Combination and Jump Series: Axel-Loop-Double Loop-Euler, 3-Turn, 3-Turn, Double Flip

h. CONNECTING JUMPS

A Connecting Jump is a single rotation jump that is used as a link to jumps with more than one rotation in a Combination. The OB Loop and Euler are commonly used as Connecting Jumps.

Examples:

5-Way Combination: Axel-Loop-Double Mapes-Euler-Double Salchow
(Connecting Jumps: Loop and Euler)

5-Way Combination: Waltz Jump-Loop-Mapes-Euler-Salchow (No Connecting Jumps)

i. SET-UP JUMPS

A Set-Up Jump is a Half Turn Jump, which precedes a more difficult jump in order to facilitate an easier or more rhythmic entry into the take-off of the harder jump, and generally not considered as part of a Combination. When the Waltz Jump, for example, is used as a “step jump” in connection with the OB Loop or Double Loop, it is considered a Set-Up Jump.

Exception: In the Junior Olympic Program, Set-Up Jumps performed in connection with any other jumps are ruled as being part of a Combination.

j. VARIATIONS TO STANDARD JUMPS

Free skating, by its very definition, allows for free choice in the routine’s content items. It is not essential that the skater’s program contain only recognized jumps as listed in this manual. To have such a ruling would eliminate experimentation and future progress of the sport, as well as defeat the intent of free skating. All content, however, must fulfill the requirements of good form and taste.

A Jump Variation is any hop, leap, or jump that is out-of-the-ordinary, or may not be listed in this book. Variations would include such items as: Split, Mazurka, Tuck, Statue-of-Liberty, Pisces, etc. Also, standard or recognized jumps with varied arm positions, which are visually pleasing and musically interpretive, are considered Jump Variations. These items, if performed well, but not in excess, should be awarded more credit in Content of Program (Technical Merit) and Manner of Performance (Artistic Impression).

Some Jump Variations are:

- (1) SPLIT - A leap or jump in which the legs are extended away from the body as far as possible.
 - (a) FULL SPLIT - Hips across the leg line, with one leg extended in front and the other in back.
 - (b) STRADDLE SPLIT - Hips in-line with the legs, both legs extended down and outward to the side of the body.
 - (c) RUSSIAN SPLIT - A Full Split with the legs parallel to the seat and toes pointed upward. Legs are generally in a wide “V” shape in front of the body with arms extended toward the feet.
 - (d) STAG SPLIT - Similar to a Scissor Split, except the front leg is bent at the knee with the foot brought up under the body.
- (2) MAZURKA - Scissoring action with legs extended downward and straight, feet crossed below the knees.
- (3) TUCK - Both legs held tightly together and bent at the knees and hips so as to bring the feet up under the body.
 - (a) CANNONBALL TUCK - Both legs tucked under the body with both arms wrapped around the legs.
 - (b) SHOOT-THE-DUCK TUCK - One leg extended forward similar to the front part of a Scissor Split, while the other leg is tucked under the body.
- (4) STATUE-OF-LIBERTY - One hand extended high over the head while the other hand is held tightly across the mid-section of the body, bent at the elbow.
- (5) PISCES (Arch Back) - A partial backbend in the air with the legs and arms rounded backward.

k. COMMON ERRORS IN JUMPS

Cheated Take-off - The use of the toe-stop of the employed skate for jumping. Turning open, rocking over to a different edge, turning to a new edge, or any method used to give a false appearance of correctness.

Cheated Landing - The use of a toe-stop assist of the employed skate. Landing on an incorrect edge and turning or changing to the correct edge, pulled or hooked edges, two-foot landings, or any method used to give a false appearance of correctness.

Stepping Out - Usually caused from the over-rotation of a backward landing jump which cannot be controlled by landing on one foot. Not holding landing position. The landing of any Jump or Combination must be held long enough to show balance and body control in order to receive full credit for the item.

Broken Rhythm on Combination Jumps - Jumps executed in a Combination should flow from one jump to the next without a noticeable hesitation. Loss of balance or body control breaks the natural rhythm of the up and down motion of the jumps. Less than full credit should be given to any Combination performed in this manner.

ARF-E SPINS

1. A centered spin is a series of continuous revolutions around a stationary axis which passes through a portion of the body.
2. Spinning can be described as an attempt on the part of the skater to defy the “laws of centrifugal force”. The three dimensions of spinning are: circular momentum, centered axis, and number of revolutions. Circular momentum refers specifically to the speed of the revolutions involved in the spin; centered axis (referred to as “spotting” the spin) means the spinning axis is stationary in one spot on the skating surface; and number of revolutions refers to the number of times the skater revolves 360 degrees in one position.
3. It follows that a spin must be more than merely one revolution. It is desirable that each position of a spin be held at least three revolutions, the entrances and exits not being counted. It is possible to perform all spins in either a clockwise or counterclockwise direction. However, in the final analysis of a spin, the spinning direction is not considered. The one most important factor in any spin is the ability to control and maintain the body positions while spinning.
4. In an analysis of a spin, three component parts should be given careful consideration: the entrance, the spin, and the exit. These three factors must be the basis for evaluation of all spins.
5. Entrances into spins are varied and are designed to gain momentum for the spin itself. Extreme violent movements, excessive “pumping,” or any other exaggerated method used to gain momentum should be avoided. Travelling is common in gaining speed by the use of successive one-foot turns which increase the circular momentum of the skater before centering the spin.
6. On the exits of spins the upright position should not be considered as an additional spin unless it precedes another position. The upright position is the natural exit position for all spins.
7. Generally speaking, the use of toe-stops caused by a loss of balance, loss of edge or skate control, or loss of body position, which occurs during the entrances, exits, or spinning positions is unacceptable. In a free skating program, the judges should penalize the use of the toe-stops to deliberately slow down the momentum of the skater before or during a spin in the score for Manner of Performance (Artistic Impression).
8. There are many methods by which spins may be satisfactorily performed and many methods of entering and finishing spins. Any procedure, which produces a sufficient number of revolutions, in keeping with the accepted rules of form, shall be considered a good method. Any method that doesn't meet these requirements should be given less credit in proportion to its error.

9. SPINS CLASSIFIED

- a. Spins may be done on any edge, but should be classified into two categories: Circle Spins and Pivot Spins.
 - (1) **CIRCLE SPINS** definitely trace a circle. No wheels pivot. The skate creates a small circle (no more than one skate length radius) around the center on which it revolves.
 - (2) **PIVOT SPINS** are similar to circle spins except that one wheel pivots around which the others slide or roll.

Note: It should be recognized that a spin, which alternates from a circle to a pivot while on the same spinning edge, should be given less credit than one that remains constant as either a circle or pivot.

b. Two Foot Spins

All Two Foot Spins are Circle Spins with each skate tracing a circle around a center axis which runs through the middle of the body. The most common Two Foot Spins are: Heel-and-Toe and Crossed-Foot.

- (1) **HEEL-AND-TOE** - The Heel-and-Toe is a combination of an IB on one skate and an IF on the other skate. The front wheels of the IF edge are sliding while the rear wheels of the IB edge are doing the same. This is a very common spin and not in the least difficult.
- (2) **CROSSED-FOOT** - The Crossed-Foot Spin properly executed consists of two outside edges, one forward and one backward. The heels and knees are turned out and, of course, the feet are crossed. The knees should be kept as nearly straight as possible in this spin, else it takes on a look that is quite disagreeable.

c. One Foot Spins

No attempt is made to classify One Foot Spins into the various body positions that may be used in nearly all of them. However, the three general spinning positions are: Upright, Sit, and Camel.

- (1) **UPRIGHT** - The body spins in a standing position.
- (2) **SIT** - A spin in which the seat is lower than the employed knee.
- (3) **CAMEL** - A spin in which the body is in a continuous arched line from head through free foot while remaining no less than parallel to the floor.

All One Foot Spins should be performed with no more than three wheels on the surface.

d. Combination Spins

A Combination Spin is a spin in which the position is changed or the spinning edge is changed, or both, without involving a change of feet. There are many varieties of combinations that may be used. The important factor in Combination Spins is that each edge and/or position be maintained for the desired three revolutions (or more) in order to receive proper credit.

Examples:

- 3-Way Combination: OB Camel-OB Sit-OB Camel
- 4-Way Combination: OF Camel-OF Sit-IB Camel-IB Sit

e. Change-Foot Spins

A Change-Foot Spin is one that involves a change of feet. Although the change of feet is the basic factor, important also is that the proper edge and position be maintained for the desired minimum three revolutions prior to the change of feet and directly following.

When a skater uses Combination Spins both before and after the change of feet, these Combinations should conform to the description of Combination Spins in order to receive full credit.

Examples:

- Change-Foot: OF Camel-OB Camel
- Combination/Change-Foot: OF Sit-IB Sit-OB Sit
- Combination/Change-Foot/Combination: OF Camel-IB Sit-OB Camel-OB Sit

f. Jump Spins

A Jump Spin is a spin in which a jump is used as the means of entry. Although the jumped entry is the basic factor, also important is that the spin (edge and position) is held for the minimum of three revolutions. When a skater uses a jumped entry into a Combination Spin, the resulting spin should conform to the correct description of Combination Spins in order to be credited properly. Proportionately less credit should be given a skater who lands a Jump Spin on the toe-stop or on the incorrect edge and then rocks onto the desired edge.

Examples:

- Jump Spin: Jump-OB Camel
- Jump/Combination: Jump-OB Camel-OB Sit

g. Spin-Jump-Change-Foot Spin

A Spin-Jump-Change-Foot Spin is one, which involves a jump and a change of feet between the component spins. The proper execution of the Jump-Change is the basic factor, but also important is that the spins (edges and positions) are maintained for the minimum three revolutions, both before and after the Jump-Change. When the skater uses Combination Spins before and/or after the Jump-Change, these should conform to the description of Combination Spins in order to receive proper credit. For full credit, the jump must not land on the incorrect edge and rockover, nor use the toe-stop for take-off or landing.

Example:

- Spin-Jump-Change-Foot: OB Camel-Jump-IB Sit

h. VARIATIONS TO STANDARD SPINS

Experimentation and creativity of unusual and varied spins or spinning positions, within the realm of good form and taste, are both essential ingredients in the development of a complete free skating program.

Definition

A Spin Variation is any spin that is out-of-the-ordinary in both body positions and unusual methods of spinning. Variations would include such items as: Heel Spin, Inverted Camel, Broken Ankle, Toe-Stop Spin, Layback Upright, Twistover, etc. These items, if performed well, but not in excess, should be awarded more credit in Content of Program (Technical Merit).

Some Spin Variations are:

- (1) **Heel Spin** - A pivot spin in which the toe wheels are lifted off the floor and the heel wheels pivot at the center of the spinning circle. The most common Heel Spins are the OF Heel Camel and the OB Heel Camel.
- (2) **Inverted Camel** - A spin in the Camel position with hips and shoulders frontside facing up.
- (3) **Layover Camel** - A spin in the Camel position with the shoulderline and hipline perpendicular to the skating surface in the open position. The most common Layover Camel is the OB Layover (similar to the Inverted but not turned completely over).
- (4) **Twistover** - Same as a Layover except in the closed position. The most common Twistover is the IB Twistover Camel (executed by the free side hip and upper body closing into and under the employed side).
- (5) **Broken Ankle** - A spin in which the ankle is disjuncted to the side of the skate and spun on the edge of the front and back wheels on the same side of the skate (only 2 wheels are in contact with the skating surface). The most common Broken Ankle spins are the IB Broken Ankle Camel (inside front and back wheels) and the OB Broken Ankle Camel (outside front and back wheels).

i. COMMON ERRORS IN SPINS

Not Holding Position for Three Revolutions - By far the most common error in spinning due to the difficulty of creating and maintaining the momentum needed to spin and hold each position on a required edge. Although the minimum requirement is three revolutions for any spin, it should be recognized that the degree of difficulty of a spin increases proportionately with each added revolution.

Poor Body Posture/Position - Sit Spins not executed with the seat below the knee, Camel positions with the free leg or upper body less than parallel to the floor, bent free leg, free foot pointed downward, etc. Any position not pleasing to the eye should be considered poor body posture.

Toe-Stopping - The use of the toe-stop of the employed skate to maintain balance during a spin. The use of the toe-stop in this manner would carry the same penalty as a cheated jump.

Drifting or Traveling (not the same as Travel Camel) - An attempted Centered Spin with an axis that does not remain stationary.

Edge Rockovers - Although commonly seen on Jump and Change-Foot Spins, edge rockovers often occur with weak skaters attempting to hold one edge. Rockovers should occur intentionally and only after three revolutions of the previous edge.

Spinning Flat - Refers to spinning with all four wheels on the skating surface. A flat spin contains no edge and generally spins less than the minimum of three revolutions.

Large Spinning Circle - A spin in which the spinning circle exceeds one skate length radius. Skaters who spin in a large spinning circle generally do not complete three revolutions and display poor spinning ability.

ARFS-F FOOTWORK

1. The value of footwork in free skating routines can be measured by the fact that it is one of the three major components of the program and is considered equal in importance with the jumps and spins. Inclusion of original and interpretive footwork into a free skating routine assists the skater in lifting the performance to a much higher plane and would thus allow the judges to assign higher marks for both Content of Program (Technical Merit) and Manner of Performance (Artistic Impression).

2. Footwork Definition

Footwork is the principle means whereby the skater is able to interpret the rhythm, mood and tempo of the program's music. Sequences or parts of dances are frequently used as footwork content. The performer does not demonstrate his or her ability to skate unless the program proves this by containing a liberal amount of footwork. A variety of one-foot turns, two-foot turns, loops, changes-of-edge, and changes in direction, all in combination with each other, can be worked out by the skater and set to the music.

3. Link Steps

Link Steps between the spins and jumps should be arranged so that each movement blends into the next, in harmony with the selection of music. Laying out the free skating program onto the skating surface should be well planned and not left to chance during the actual performance.

4. Footwork Classified

In order to classify footwork, the level of difficulty in performing sequences of footwork must be divided into 3 different categories: Primary, Secondary, and Advanced.

- a. **Primary Footwork** - Steps or sequences of steps not involving turns of any kind; also leaps or hops without excessive lift.
- b. **Secondary Footwork** - Steps or sequences of steps involving two-foot turns; toe-stop turns and Half Turn Step Jumps without excessive lift.
- c. **Advanced Footwork** - All other steps or sequences of steps involving one-foot turns; One Foot Half Turn Jumps (3's, Rockers, Counters and Brackets) without excessive lift; loops and other one-foot maneuvers, such as difficult changes-of-edge or changes of lean and direction, performed alternately with both skates on or close to the skating surface.
- d. In the short program for Junior, Junior World Class and Senior World Class, flying turns (3's), Brackets, Rockers, Counters, Mohawk, Choctaw are not to be considered as recognized jumps.

ARFS –G DEGREE OF DIFFICULTY

1. Degree of Difficulty is the level of skill needed to perform an item well relative to other items of the same kind. Obviously, for most skaters, some items in free skating are generally harder or take longer to master than others. Consequently, it is the intent of this section to offer some frame of reference concerning the skill level necessary to perform these basic items.
2. Excessive repetition of the same item, without showing a variety of skating versatility must be given less credit in both Content of Program (Technical Merit) and Manner of Performance (Artistic Impression). No jump may be attempted more than three times in any USAC/RS Standard division singles routines, with the exception of single rotation connecting jumps used in combinations. Exceeding this limitation will be penalized by a minimum deduction of 10 points by each judge. In a combination jump, each jump is individually counted for purposes of this rule.
3. It should also be noted that the quantity of any items does not take precedence over the quality of those items in a well-planned program.
4. These factors are not used in multiplying but only in evaluating difficulty (in comparative terms) based on the skill needed to perform the item correctly.

a. JUMPS

Singles	Factor	Doubles	Factor	Triples	Factor		
Bunny Hop		.5		Mapes	4.0	Mapes	7.5
Waltz Jump		1.0		Toe Walley	4.0	Toe Walley	7.5
Mapes	2.0	Salchow	4.5	Salchow	8.0		
Toe Walley	2.0	Flip	5.0	Flip	8.5		
Salchow	2.0	Lutz	5.0	Lutz	8.5		
Flip	2.5	Loop	5.5	Loop	9.0		
Lutz	2.5	Euler	5.5	Euler	9.0		
Loop	2.5	Boeckl	6.5	Boeckl	10.0		
Euler	2.5	Axel	6.5	Axel	10.0		
Boeckl	3.5						

Axel	3.5	Quadruples	12.0+
------	-----	------------	-------

b. SPINS

Uprights	Factor	Sits	Factor	Camels	Factor
Two Foot	1.0	IB Sit	4.0	OF Camel	6.0
IB Upright	2.0	OF Sit	4.5	OB Camel	6.0
Cross-Foot	2.5	OB Sit	4.5	IB Camel	6.0
OF Upright	2.5	IF Sit	6.0	IF Camel	6.5
OB Upright	2.5			Layover	7.0
IF Upright	3.0			Broken Ankle	7.5
				Twistover	8.0
				Heel Camel	9.5
				Inverted	10.0

c. FOOTWORK

Primary	Secondary	Advanced
Factor	Factor	Factor
1.0	5.0	10.0

ARFS-H FREE SKATING PROGRAMS

1. In free skating, a well-balanced program of the three free skating components (jumps, spins, and footwork) is performed to music of the skater’s choice. Since free skating is judged only during the performance of this program, it is extremely important to create a routine that displays the skater’s ability, strength, energy, image and versatility in the relatively short time allotted to the performance. Consequently, there are three areas to consider: (1) Music Selection and Composition, (2) Arrangement of Content, and (3) Choreography.
2. It must be understood that the scope of artistic free skating is in no way limited to the guidelines set forth in this section. To discourage experimentation of new and different styles, or concepts, would defeat the intent of free skating and the future progress of the sport.

ARFS – I GUIDELINES TO MUSIC SELECTION AND COMPOSITION

1. Selection of music is a personal preference for the individual skater. First, the skater should perform the program with genuine feeling and understanding. In order to do this, the skater must respond to the music that accompanies the performance and not just simply skate to background music. The music must adequately express the feelings and images the skater wishes to communicate, as well as allow the freedom to display skating ability and talent.
2. The musical composition of the program is usually begun with a fast tempo, shifting to a slow movement and picking up with a fast ending. A variation of the format would be to start with a soft, slow beginning moving into a stronger rhythm, then shift into quick, light music for footwork, becoming slow again-only to move into a strong and vibrant ending. Only if a skater is extremely artistic should a slow ending be used.
3. The transition from one piece to another is very important. Pieces of music should be chosen that are similar in style and tone so that musical transitions are not jarring. For example, starting with classical music in the opening of the program, then switching to rock-and-roll, and finally returning to classical again. However, a change of pace or variety of moods to show the skater’s versatility and energy is desirable. This can be attained by blending pieces of music together which are harmoniously pleasing to the ear. There is no limit to these musical “cuts” as long as the flow of the program is not impaired. Furthermore, an experienced technician should splice the musical selections together so as not to allow harsh notes to be heard, nor abrupt changes in melody, rhythm and phrasing.
4. Vocal music, which expresses a message through recognizable words, is not permitted in free skating competition. However, music containing human sounds such as humming or other vocal sounds, which may enhance the quality of the music, may be used in the realm of good taste.
5. As a reminder, the official timing begins when the skater moves any part of his or her body. Consequently, musical introductions may be used to prepare the mood and rhythm for the skater before the first movement commences. Bleeps, whistles, or other “starting gun” sounds should be avoided.

ARFS-J GUIDELINES TO ARRANGEMENT OF CONTENT

1. Pattern

The program should be patterned so that the various types of content are distributed proportionately and not lumped together either at one particular position or at one location on the skating surface. The routine should cover the whole floor in an interesting and varied manner, giving the impression of continuity, not a collection of successive isolated highlights.

2. Harmonious Placement of Contents

a. Placement of Items (Jumps, Spins and Footwork) -Placement of the items on the skating surface should be arranged evenly, yet providing enough area to utilize speed, flow, and visibility of the content. The skater must use the entire floor without displaying obvious effort to avoid the barriers, awkwardness, or dependence on direction of entry into an item.

b. Floor Directional Patterns

A combination of the following floor pattern guides will help make a well-balanced free skating program arrangement. The importance of varied patterns and the use of the major portion of the skating surface cannot be over-emphasized in free skating. The skating surface to a teacher is what the canvas is to a painter. A free skating presentation is incomplete if parts of the creative area are unused.

ARFS-K GUIDELINES TO CHOREOGRAPHY

1. Choreography is something very personal, and every individual skater should have some little trademark that separates him or her from the others. Appropriate expression of the character of the music is the determining factor in the artistic level of the program. Too often, movements are done in which the quality has no connection to the music, no matter how well performed by the skater. The skater's ultimate goal should be then to allow the music to evoke the character of the movements, showing that what the skater is doing technically is relevant to the performance as a whole. The melding of movements from one into another creates the choreography of the program.
2. Another important element in the execution of a well-choreographed program is the ability to perform difficult intricate maneuvers with apparent ease and effortlessness. In order to facilitate this, a variety of all types of skating dance steps, turns, body positions, omni-directional movements, etc. (within a skater's level of proficiency) should be incorporated and planned into the program and well-practiced.

ARFS-L JUDGING PRECEPTS

1. Technical Execution

All evaluation must begin with consideration of accurate execution of the prescribed movements. Any evaluation must consider the skater's artistic performance and shall be directly dependent upon technical execution. Where music is involved, the skater must demonstrate an ability to interpret that music.

2. Falls

A skater falling on content items shall be penalized both in Content of Program (Technical Merit) and Manner of Performance (Artistic Impression). The amount of penalty shall be evaluated according to the circumstances of the fall, as demonstrated by the lack of control causing the fall. A fall is defined as "the complete loss of balance involving body contact with the skating surface."

3. Cheats

A skater whose items do not conform to the textbook definition (i.e., cheated jumps and spins) of "complete" shall be penalized under Content of Program (Technical Merit) as well as under Manner of Performance (Artistic Impression). A cheated item is a content item performed incorrectly while having the false appearance of correctness. A cheated item such as a jump with insufficient rotation, pulled take-off, or pulled landing or a spin using the toe-stop to balance should, in no instance, be condoned by the judges.

4. Balance

The judge shall give more credit to a well-balanced program than to a program with only one area of outstanding excellence.

a. Balance includes:

- (1) Execution of jumps, spins and footwork of comparable difficulty
- (2) Musical interpretation
- (3) Utilization of the entire skating surface

(4) Spacing of the content

- b. In a balanced routine, a variety of initial spin edges and positions are of vital importance.

If a skater attempts an item or items and falls in the attempt, when it is obviously apparent that it is beyond his or her ability, the judge shall severely penalize the skater in both Content of Program (Technical Merit) and Manner of Performance (Artistic Impression).

PAIRS SKATING

SECTION I - PROGRAM

ARP-I-A ARRANGEMENT OF CONTENT

The program should be patterned so that the various types of content are not lumped together either at one particular position in the routine or at one location on the skating surface. Programs should cover the whole skating surface. The program should give the impression of continuity, not a collection of successive isolated highlights.

1. Patterns

A combination of floor directional patterns will help make a well balance pairs program. The importance of varied patterns and the use of the major portion of the skating surface cannot be over emphasized in pairs skating. The skating surface to a coach is what the canvas is to the painter. A free skating/pairs presentation is incomplete if parts of the creative area are unused.

2. Circle Patterns "A" and "B"

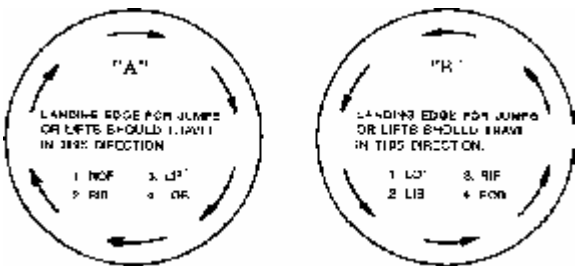

Note: If proper landing direction is used, skaters should have no problem with a natural exit because of barriers.

3. "S" Patterns

"S" Shape Pattern "A"

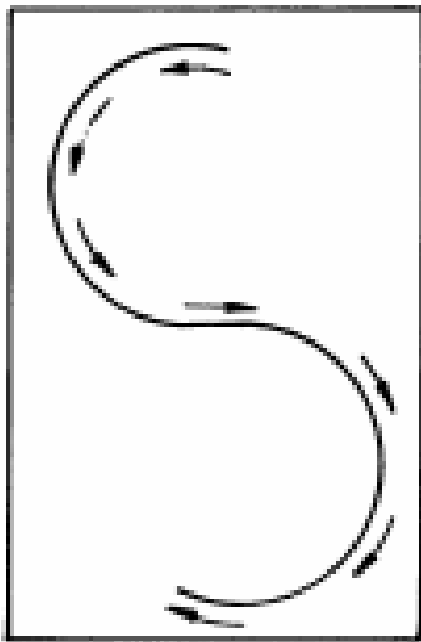

Reverse "S" Shape Pattern "B"

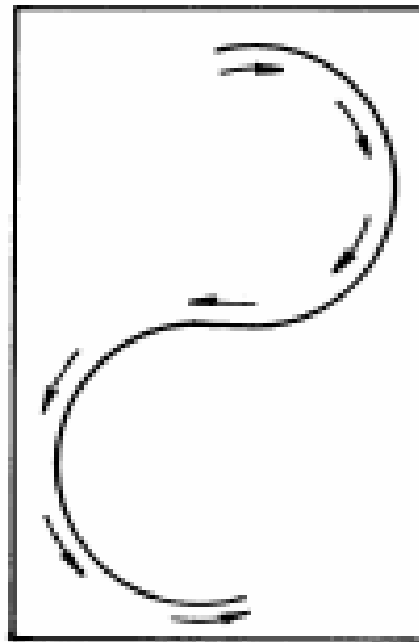

4. Diagonal Pattern

5. Straight Line Patterns - Short "A" and Long "B"



ARP-I-B FOOTWORK CLASSIFIED

In free skating, there are three classifications of footwork proficiency: primary, secondary, and advanced. Pair skating utilizes all of these areas and also adds a few methods of execution, which are unique to the discipline. The execution of footwork is an integral part of the overall skating performance. Perhaps more than any other component, well-executed footwork can convey the essence of the pairs skating program. The importance of good footwork is also obvious to the judge, who will immediately notice the difference between a program, which has successfully blended the music, footwork, and content compared to one, which focuses only on the execution of content.

1. **Primary footwork**, or a series of steps not involving turns, consists of cross in fronts, cross behinds, leg swings, and chasses.

2. **Secondary footwork** consists of any of the above items but adds the backward execution of these items by way of two-foot turns. These turns include Mohawks and Choctaws, which may be executed in the open, closed, dropped or held positions, and completed from forward to backward or vice versa.
3. **Advanced footwork**, the most difficult category, employs the use of loops and any of the one foot turns used in roller-skating. These turns include three turns, rockers, counters, and brackets. The creation and execution of advanced footwork segments should reflect the highest technical abilities of the sport.
 - a. **Side-by-Side Footwork**
During the execution of side-by-side footwork in pairs skating, the movement of the body, arms, legs, and hands should match as closely as possible, presenting the team as one.
 - b. **Contact Footwork**
 - (1) Contact footwork is a compulsory item in pairs skating and, like other parts of the program, must be practiced for many hours each week. When presenting contact footwork, a pairs team may execute the same movements as are found in individual footwork. Any segment of contact footwork movements must be completed while the team maintains some sort of physical contact.
 - (2) When contact footwork is skated to lively or bouncy music, these segments will travel quite a distance down the skating surface. At other times, the footwork may be restricted to a very small area of the skating surface, enhancing a slow section of music in a circular pattern. In any instance, it is important to remember that the insertion of contact footwork must fit the musical selection and not simply be added to fulfill some preconceived notion of the event requirements. In order to add any value to a pairs skating program, footwork of any type must complement the music, as if the ideas for both the music and the footwork were created at the same moment.
 - (3) Although performed mostly “in line,” there are certain times in some programs where, while performing turns, the team members could be aligned one behind the other. Whatever the position of the partners, the steps, hops, and body leans should be constructed with imagination. Although there are many variations of steps, it must be remembered that edges create motion and that motion give the impression of the spectacular — an important effect from the viewpoint of judge and spectator alike.
 - (4) Putting good footwork segments together takes time. The coach may have to listen to the musical selections many times in order to arrive at the proper balance of technical difficulty and musical interpretation. During this learning process, the team and coach should experiment with as many varieties of footwork as possible, utilizing various step combinations until the segment perfect for the music is constructed.
 - c. **Shadow Footwork**
 - (1) Shadow footwork is exactly what the name implies: footwork segments of varying difficulty completed by each partner as a matching image of the other. Shadow footwork should involve a duplicate action of one team member’s movements to the other which may consist of any action, motion, or series of steps. The simplest way to picture the execution of a shadow move would be to imagine the team performing spread eagles, with one partner behind the other.
 - (2) Shadow footwork may be accomplished with the partners skating either side by side or “in line” but separated. Regardless of divisional level, all pairs programs should contain at least one segment of shadow footwork. The performance of this footwork not only demonstrates the ability of the team to skate together in unison, it also reveals the strengths of each member’s individual skating abilities.
 - (3) Many hours of practice, both on and off the skating surface, must be spent in perfecting shadow footwork. It is one of the most difficult and important items to master. The use of mirrors is an important aid to matching the body movements of each pairs partner. The mirror enables the team to immediately see the arm and body positions and allows them to “feel” each position as they see it completed.
 - (4) No matter what type of footwork is included in the final pairs skating program, each type should be well planned and well executed. The use of arms, hands, legs, and other expressive body movements serve to enhance the value of footwork and will blend the movements to the music like the conductor manipulating the members of an orchestra. Every effort should be made to match each step in the segment as closely as possible, projecting the image of symmetry for which all pairs teams should strive.

ARP-I-C CATEGORIZING LIFTS

When properly performed, the execution of the overhead lift can be the most breathtaking component of any pairs skating program. Many lifts make up the repertoire of the pairs skaters. The following lift listing is designed to provide judges, skaters, and coaches a general idea of the type and relative difficulty of each of the different lifts. It should be noted that each skater and/or team may find some items more difficult to complete due to a variance in the height, weight, or technical proficiency of the partners. In general, teams in which each partner is similar in size require a greater degree of unison, timing strength, and rhythm to complete the moves.

I. Lift Difficulty

The most difficult lifts for any pairs team to accomplish are the combination lifts, which are composed of two or more of the lifts listed below. The possibilities for combination lifts are endless. The degree of difficulty for each combination, however, can be measured by the difficulty of the individual lift positions rather than the number of positions attained in each lift. In order to receive full credit as a valid part of the combination, each position in a combination lift must be sustained for two (2) full rotations.

Lifts
(listed in descending order of difficulty)

- a. Militano
 - 1. Star position
 - 2. No-handed by the woman
 - 3. One-handed by the woman
 - 4. Two-handed position

- b. Twist lifts
 - 1. Triple (3) twist
 - 2. Double (2) twist

- c. Kennedy
 - 1. One-handed, Kennedy position
 - 2. One handed, layout position
 - 3. Two-handed, Kennedy position
 - 4. Two-handed, layout position

- d. Cartwheel
 - 1. T position
 - 2. T position, legs split
 - 3. No-handed, cartwheel position by the woman
 - 4. One-handed, cartwheel position by the woman
 - 5. Two-handed, cartwheel position by the woman

- e. Pancake
 - 1. One-handed pancake position
 - 2. Two-handed pancake position

- f. Press (or Forward Extension)
 - 1. One-handed, press position
 - 2. One-handed, layout press position
 - 3. Two-handed, press position
 - 4. Two-handed, layout press position

- g. Airplane
 - 1. No-handed airplane position by the woman
 - 2. One-handed airplane position by the woman
 - 3. Two-handed airplane position by the woman

- h. Kick-over Flip
 - 1. Kick-over with a twist
 - 2. Kick-over

- i. Lutz or Flip lift
 - 1. Full split position
 - 2. Reverse split position, one-handed
 - 3. Reverse split position, two-handed
 - 4. Half-turn Lutz or Flip lift
- j. Around the back
- k. Pass Over Axel
 - 1. One-arm Pass Over
 - 2. Two-arm Pass Over
- l. Bucket or Pull Through

2. Special Notes on Lift Execution

While each lift is accomplished in a slightly different manner, there are certain fundamental rules which must be observed in the teaching and execution of every lift. A few of these important guidelines follow.

When beginning any lift, a combination of the man bending down and the woman jumping up will make it easier for the man to raise the woman to the proper lift position. The man should never have to lift the woman from the floor—he should only lift the weight of the woman on her way up.

While rotating, the man should never push the inner forward edges. He should use his entrance speed to keep the lift moving down the floor and should not use his toe stops at any time during the rotation of the lift. He should use a series of quickly-executed forward and backward mohawk turns, accomplished in the heel to heel position, to complete the required number of rotations. The man's body position should be upright, with forward lean and only the knees bent when necessary.

In all lifts, the woman must sustain her position as long as necessary until the lift is completed. The lift will be completed with both partners rolling on solid edges, with landing positions extended as much as possible. The employed knees of both partners should be bent as much as possible to obtain the desired landing position.

a. Bucket or Pull Through

The bucket lift is a fundamental lift and a good lift for beginners. As the man rolls backward and the woman rolls forward, the woman grasps the man's right hand with her left hand. After a stretch of the free legs, the man pulls the woman towards him, bending both knees when she gets close and rolling on his right outer back edge. Bending her right knee, the woman jumps up to the man's left hip while turning. At the completion of the move, she reaches around the man's neck with her right hand and grasps his shoulder.



b. Pass Over Axel

To begin the lift, both partners should be rolling on outer back edges. The man's right hand is around the woman's back, with the woman's left arm around the man's right shoulder. As both partners step to left outer forward edges the woman, on the man's right side, will swing up to a position facing him on the first half rotation. The man then changes his holding arms from right to left and continues the remaining half rotation, placing the woman down backward at his left side, with both partners rolling on right outer back edges. In the landing position, the body position of each member should match as closely as possible with heads erect, backs straight, free legs extended and with the toes pointed down and out.



c. One-Arm Pass Over

The entrance to this lift is the same as the regular pass over, except that on the take off the woman turns her body one half turn. With her body resting on the man's right shoulder, the woman sustains her position by pushing up with her right arm. The man then rotates one half turn, places down the woman on a right outer back edge and matches her landing position on a right outer back edge.



d. Around the Back Lift

The starting position for this lift has the man rolling forward on two feet while the woman rolls on a left inner back edge. With his left hand, the man will grasp the woman's left underarm (palm facing up, thumb toward her chest). The man's right hand is extended over his head, grasping the woman's right wrist or hand. She grasps the man's right wrist or hand.

As the man bends to lift the woman, she will toe plant with her right foot and press up to the man's left shoulder with her left hand. As she begins this motion, the man continues his lift using the woman's momentum and raises the woman directly up and behind his body. At the apex of the lift, the woman will be resting on the man's back, with both partners facing in the same direction, arms fully extended. The woman splits her legs with toes pointed, sustaining the position with her left hand while keeping her head erect and her back as straight as possible.

After the completion of the required rotations, the man will bring the woman around and place her on a right outer back edge in front of his body as he steps to a left outer forward edge. Holding the woman's right hand in his left, both partners present a strong landing position. As always, good posture should be observed, with the free legs fully extended and the toes pointing down and out.



e. Lutz or Flip Lift (Reversed Split Position)

Both partners roll backwards, with the woman positioned on the man's right side. The woman's left hand is on the man's right shoulder, the man's right hand under the woman's left underarm, the woman's right and man's left hands joined in front of the body and slightly down. The woman toe plants with her right foot, beginning her ascent as the man raises her to a reversed split position. In the fully extended position, the woman will be facing towards the man.

The woman will finish on a right outer back edge and, as long as the required number of rotations are completed, the man's landing position is optional. The man may face either forward on a left outer edge or backward on a right outer edge, matching the landing position as much as possible. The usual posture for lift landings should be maintained.



f. Lutz or Flip Lift (Full Split Position)

The team begins the lift rolling backward on either the inner or outer edge of the left skate. The woman's left hand is on the man's right shoulder, the man's right hand is under the woman's left underarm, his left hand and the woman's right hand joined in front of the partners.

At take-off, the man bends his knees as the woman toe assists with her right foot. Jumping up, she pushes hard with her left hand, leaning over it as the man pushes up with his right hand. As he balances her weight with his left hand, the woman must reach full extension, legs in a full front split with back straight and head up.

The landing position is optional: the woman may land in front of the man on a right outer back edge (with the man finishing in front on a left outer forward edge); or the woman may rotate the half turn in front of the man, landing on a right outer back edge with the man matching her position. Whichever method is used, good posture should prevail as indicated by straight backs, heads up, and free legs fully extended with the toes pointed down and out.



g. Swing Lift (one rotation)

Both partners roll backward, woman on man's right side, man's right arm around woman's back, woman's left arm around man's right shoulder. Woman holds man's left hand with her right hand, both step to LOF edges with man swinging woman aloft as they step, with woman swinging her right leg up as the man swings her up. Woman kicks her legs together as her right leg reaches its maximum height. Man turns one rotation, landing woman on ROB edge in front of him as he rolls on LOF edge.



h. Kick Over Flip Lift

The lift begins with the skaters in the same position as in the Flip or Lutz lift. The woman is raised to full extension, locking her left arm while stretching her right leg over the man's head. She should maintain a straight body line. The man lifts with his right hand and arm. At the top of the extension (as the woman kicks over), he releases his right hand hold, catching the woman with either hand as she assumes the landing position. Both partners should complete the landing on a right outer back edge, the woman doing this without any break in posture. The standard posture requirements should be observed.

NOTE: During the execution of this lift, the man should maintain a straight body axis, with no noticeable bending at the waist. The man does not rotate during this lift and should not use his toe stops at any time.



i. Kick Over the Head Flip With a Twist

The starting position is the same as the Kick Over Flip. After the woman reaches the fully extended position with her right leg over the man's head, she will make slight contact with her body to the man's shoulder. When the man feels this contact, he will raise his shoulder by lifting with his legs. When the woman feels this, she will snap her body into a rotating position, rotating one turn and landing on a right outer back edge in the same position as in the Kick Over Lift.

NOTE: During the execution of this lift, the man must maintain a straight body axis. The man does not rotate—only the woman performs a rotation during this lift.



j. Airplane Lift (basic take-off)

This lift begins with the partners facing each other, man rolling forward. Grasping the woman's hips (thumbs facing in), the man bends to start the lift as the woman toe plants with her right foot. Once the lift begins, the woman presses her body over his shoulders and extends her arms. The man raises the woman's hips over his head to the extended position, where the woman fully splits her legs, arching her back and lifting her head. She must keep her arms locked during rotation. The man lowers the woman in front of him, placing her on a right outer back edge, while he skates to a left outer forward edge. Good posture should be maintained.

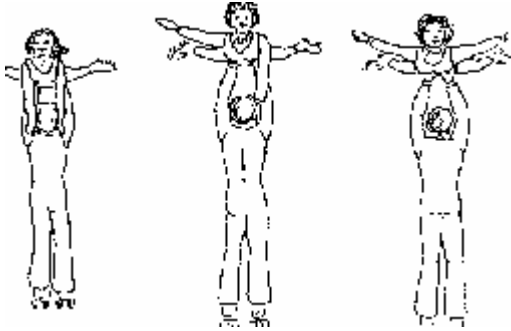

k. **Airplane Lift (advanced take-off)**

In this version, the position of the partners is reversed, with the man rolling backward rather than forward. The man grasps the woman's left hand with his right and pulls her towards him as he bends down. Rolling on a left outer forward edge, the woman bends forward and jumps up over the man to a fully extended airplane position. The landing positions will be identical to the basic Airplane lift.

NOTE: In all divisions, from a scoring standpoint, this method of take-off should be given more credit than the basic take-off position. During this lift, the woman may hold on with both hands, one hand, or choose to release her grip completely.

l. **Press Lift (two-handed position)**

Man faces woman, man's right hand holding woman's left hand, man's left hand holding woman's right hand. The press position must be maintained without losing hand contact from the original hand position as the man lifts the woman aloft to the extended position. Like other lifts, the man should mainly rely on the momentum of the woman to begin the lift, pushing with both arms until the full extension is reached. Once the woman assumes the extended position, the man rotates around his axis, in a level position with arms locked. The landing position for the Press lift is optional, but in each, the body positions assumed must display the good posture characteristics found in all skating: free legs straight, backs straight, heads up, and toes pointed down and out.

NOTE: When rotating, the man should perform close, tight mohawks which enable him to rotate around his body axis without noticeable tilt either forward, backward, or sideways. This practice should be standard on all lifts.

Optional take off: The man rolls backward while the woman rolls forward. The woman grasps the man's right hand with her left. As he pulls the woman toward him, he grasps her right hand with his left and she jumps up and over the him. The remainder of the lift is the same.



m. **Press Lift (one-handed position)**

The Press lift executed in the one-handed position begins in the same manner as the standard position. During the change to the one-handed position, the man will move his right hand in, toward the center of the woman's body. The woman will shift her weight over the man's right hand, locking her arm and body position while her body moves slightly forward. The lift position should not be changed, it should remain strong and locked as stated before.



n. Press Lift (two-handed, layout position)

The Press lift accomplished in the two-handed position is done in the same manner as previously explained except that the woman will shift her position forward and bring her legs together, keeping them locked straight with toes pointed. Her body should remain parallel to the skating surface. The landing position is optional as long as it is strong with straight backs and straight free legs, heads held up, toes pointed down and out.



o. Press Lift (one-handed, layout position)

In the one-handed layout position, the man rolls forward as the woman rolls backward. The woman grasps the man's left hand with her right hand, while holding his right hand with her left, palms touching. The man bends to start the lift as the woman toe assists with either the right or left foot, jumping up and over the man's head. As she does this, she shifts her body weight slightly forward and assumes the front split position (legs and back straight, head up, toes pointed down and out). The woman will lock this position and retain it until the rotations have been completed.



p. Pancake Lift (inverted Airplane)

This lift begins with both partners rolling backwards, man behind the woman. The man grasps the woman's lower hips (right hand on right hip, left hand on left hip), with the woman holding the man's wrists. As the man bends his knees, the woman toe plants with her right foot, leaping up and over the man's head. The man raises the woman to the center of his body axis, locking his arms and wrists. At the height of the lift, the woman's body position should be parallel to the floor, with legs, body and head held extended and motionless except for the man's rotation. The landing position is optional as long as a strong body position is maintained.



q. **Pancake Lift (one-handed position)**

This lift starts the same as the two handed position, with the man's hands positioned either on the hips or left hand on the hip and right hand at the middle of the woman's lower back. At the top of the extension, and depending upon the original hand position, the man will move his right hand to the middle of the woman's lower back, releasing his left hand and balancing her weight on his right hand. The man must keep his arm and wrist locked to ensure no motion other than rotation. The woman should maintain a strong, extended position. The landing position is once again optional, good landing posture is a must.



r. **Cartwheel**

Both partners begin the lift rolling backward. The woman's right hand holds the man's left, her left hand on the man's right shoulder. The man's right hand is on the woman's left leg, near her tight line. As the man bends into the lift, the woman will take-off (using either a flip or Mapes take-off) bringing her right leg up and toward the ceiling in a split position in line with the man's body axis. The left leg should remain parallel to the skating surface. The woman must retain a strongly arched back (not hanging over the man), and the overall effect should be that of an outer forward camel position. The woman's right hip and shoulder should remain slightly open, with the majority of her weight in the man's right hand. The woman may use her right hand to maintain both her balance and lift position.

With shoulders parallel to the skating surface, the man will turn close, tight Mohawks. During the landing, he will release his hold with his left hand and grasp the woman's right hip, bringing the woman down in front of him on a right outer back edge.



1. Cartwheel (one-handed position)

This position is the same as the standard Cartwheel, except that the woman releases her right hand once in the air. The landing position is optional.

2. Cartwheel (no-handed position)

This lift also executed in the same manner, but the woman releases both hands. The landing position is optional.

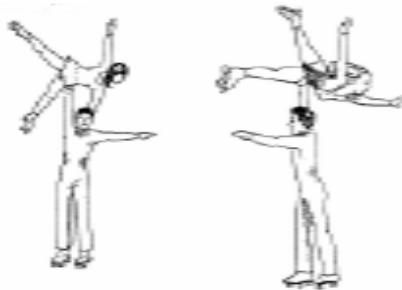

3. Cartwheel (T position)

Accomplished as the standard Cartwheel, but the woman brings both legs together in the “T” position. This position should be executed parallel to the skating surface, maintained as tightly as possible with no movement. At no time should the woman shift her body weight to the right or apply too much pressure to the man’s left hand. If this occurs, the release will be difficult to accomplish. The man’s wrist and arm must remain rigid, with his shoulder parallel to the skating surface. The landing position is optional.



s. Kennedy Lift

The standard execution of this lift begins with the partners facing each other, man rolling forward. Both partners should grasp hands left-to-left and right-to-right, using the thumb pivot grip. The man bends as low as possible under the woman’s left hand, raising the right hands over the head. The woman then toe plants with her right foot to begin the upward motion as the man lifts with his left hand. The woman will rotate her right side over and around, pushing down on her right hand and locking both the right and left hand at the fully extended position.

During the lift rotation, both partners must maintain parallel shoulder positions. The woman should be in the full split position: legs straight and toes pointed down and out. The landing position is optional as long as the proper landing posture is assumed.

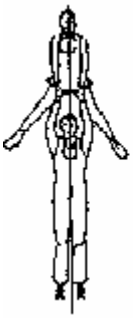

1. Kennedy Lift (layout position)

Begun in the same manner as the standard Kennedy. At the top of the extension, however, the woman begins to shift her body forward, bringing her legs together and locking her body from head to toe. Her head should be up and her back straight, with no movement visible once the position is attained. The man should lock the woman in this position over his own body axis and rotate with his shoulders parallel to the skating surface. This lift should be executed with speed and turned by the man with tight, close mohawks. The landing position is optional.

2. Kennedy Lift (one-handed layout position)

This lift uses the same entrance as the standard Kennedy lift but at the apex of the Kennedy position, the man moves his right hand in to the center, positioning it below the woman's navel. As he does this, the woman moves her left hand out to the side, balancing her weight on the man's right hand to keep her body parallel to the floor in the layout position. This handhold must remain firm and the woman's position must stay solid with no noticeable movement throughout the rotation of the lift. The landing position is optional.



t. Twist Lift (double or triple rotation)

Both partners should be rolling backwards with the man positioned behind the woman and leading her in the direction of travel. He should have his hands on the woman's hips with her hands covering his. The woman executes a Lutz or flips take-off and immediately attains either a full split or full extension, followed by the planned number of rotations. During these rotations, the woman must turn freely in the air. Prior to the landing, the woman must be caught by the man and assisted to a smooth landing on an outer back edge.

On the landing, the partners may face either the same direction or each other. However, the face-to-face landing technique is more difficult and considered to be the superior technical execution.

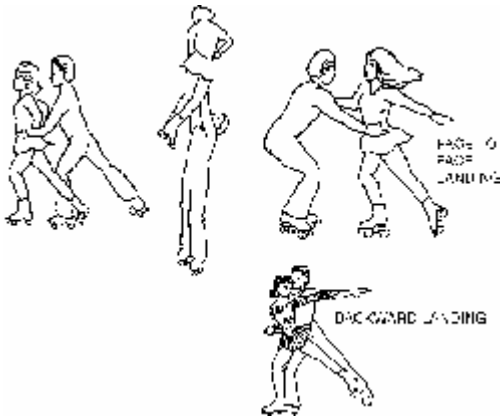

u. Militano Lift (or Chair Lift)

The take-off used in the Militano is the most difficult of all to execute. The lift is begun with both partners rolling backwards. The partners should grasp opposite hands—left to right and right to left—using the thumb pivot grip. On the take-off, the man’s left hand and woman’s right hand are held low (near the woman’s buttocks), while the man’s right hand and the woman’s left are held overhead.

At this point the woman, who is positioned directly in front of the man, is lifted from a right outer back take-off and rotated one half rotation to the apex of the lift. In this position, the woman moves her left hand under her left leg, made easier by keeping the left leg bent until the hand is in position. Once this is done, the basic position finds the partners facing opposite directions with the woman sitting on both hands. Her left leg is straight while the right leg is bent, in a “hurdler” position.

To maintain this position, the man must keep his arms locked while the woman must stay rigid and bent slightly forward. Both partners must rotate at exactly the same rate of speed. During descent, the woman should be sitting on her right hand.



I. Militano Lift (one-handed and no-handed, chair position)

This lift is executed the same as the standard Militano, except that at the peak of the lift, the woman shifts all of her weight to her left leg and hand. When this is done, it is possible for the woman to release her right hand from the man’s left. Upon release, the woman will automatically rotate an additional one quarter revolution to her left, moving her left leg parallel to the man’s shoulders.

To switch to the no-handed position, the woman must release both hands, removing the left hand first to allow the man to grasp her left leg. This is more easily accomplished by keeping the weight slightly to her right. After the left hand is released, the weight is shifted back to the left leg (and the man’s right

hand) to allow the release of her right hand. The lift landing is optional as long as the woman placed on a clean, outer back edge in the standard landing posture.



2. Star Lift

The Star lift is a variation of the no-handed Militano. Both of the woman's legs remain in the straight, split position, with the left leg leading the right. The landing position is optional, provided that the man places the woman on a clean, outer back edge without the assist of his shoulder.



ARP-I-DCATEGORIZING SPINS

1. Importance of the Spinning Axis

- a. In addition to edge quality and body position, the axis (the baseline of rotation for turns) is the main ingredient of a good spin. When the body is placed in the correct position and a pure edge is pressed, the body begins to spin around the axis. The more the body stretches away from the partner during a circle-type spin, the stronger the spin becomes as the spinning axis moves between the two skaters.
- b. Pair spins maintain their momentum (or spinning energy) through two methods: by pulling away from each partner or from the axis of the spin. The more the skaters pull away from the center or axis of the spin, the faster the skaters are able to spin. As the partners stretch their spinning position, they increase their "spin energy." During the Pull Camel, for example, the man spins on the axis while the girl spins around it. The stronger the pivot used by the man, the stronger the position of the spin will become.

2. How Size Affects Spinning

As we have mentioned previously, the nature of pairs skating demands that all moves be executed as one. When partners spin, alignment of the body by the degree of knee bend creates and stabilizes a balanced spinning position. If the woman is too small in stature for the man, it becomes impossible to maintain a satisfactory spinning position.

3. Difficulty of Content

Combination pairs spins are comprised of two or more of the spins listed below. The possibilities for combination spins are endless, but the difficulty of each combination should be determined by the technical difficulty of the individual spin positions, not the number of positions in the spin. Each position must be held for two full rotations—changing from one position to the next is not included in total position count.

4. Spin Entrances

There are many techniques used to initiate spins, but the most common involves the partners circling at a distance around a common center, moving closer and closer until they meet at that center. Other methods may include pulling the woman into a spin, or using a recognized jump such as catch Axel camels. Whatever method is used, the variety and inventiveness used in designing spin entrances and exits will serve to enhance both the spin and the overall program.

The following list of spins provides skaters, coaches and judges with a general idea of the relative difficulty of the spins. Once again, it should be noted that each skater and/or team may find one or another item easier or more difficult due to height, weight, or technical ability of either partner. Teams close to the same size will find it more difficult to do "impossible" and "overhead" spins. Teams where the woman is smaller in stature will find it more difficult to meet and generate speed at the beginning of a spin, as well as create the desired body lines and overall aesthetic appearance. The characteristics of each team and spin must be evaluated on an individual basis.

5. Spins *(listed in descending order of difficulty)*

a. Impossible

1. Impossible sit with a twist
2. Impossible sit
3. Impossible Camel with a twist
4. Impossible Camel

b. Hazel spin

c. Lay Over Camel

1. Lay Over Camel (woman without hand contact)
2. Lay Over Camel

d. Face-to-Face sit

1. Face-to-Face outer back sits
2. Face-to-Face inner back sit

e. Tango spin (face to face Camel)

1. Tango position (woman spinning on left inner back, man spinning on right outer back)

f. Pull Around Camel

1. Pull Around Camel over Lay Over (inverted)
2. Pull Around Camel over Camel
3. Pull Around Camel, side by side position
4. Pull Around Camel to catch waist Camel

g. Hand in Hand spins

1. Outer forward Hand in Hand Camels
2. Outer back Hand in Hand Camels
3. Outer forward Hand in Hand Upright
4. Outer back Hand in Hand Upright

h. Death Spiral

NOTE: While this list does not exhaust the possibilities of other spins and positions, it does contain the majority of spins used in pairs skating today.

6. Pairs Spins — The Basics

Just as in any other branch of the sport, there are certain “building blocks” which are both unique and necessary to the successful execution of the content. A summary of these basic components follows.

7. Circle Spins

Timing is very important in the proper execution of circle spins. The partners start together, pushing forward and away from each other on right outer forward edges. When entering the spin, the partners must maintain equal speed and remain positioned directly across from each other on the imaginary arc. Halfway around the circle, both partners turn backward (using either a three turn or mohawk) and begin skating toward each other on a right inner back edge.

Just as the partners meet, they step to left outer forward edges and grasp each other, increasing the depth of the left outer forward edge. At this point, it is very important for the partners to remain on edges (not flats) as they begin to spin around each other. From this point, a variety of spins, edges, and holds are possible.

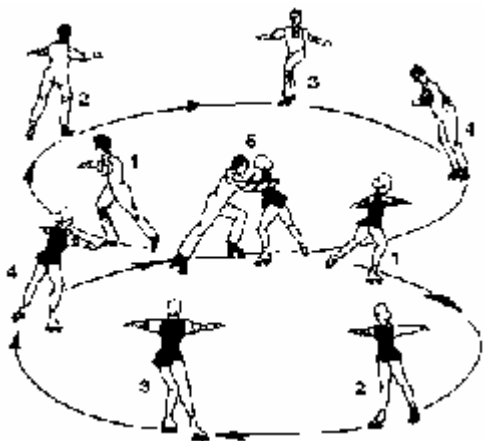

8. The Outer Back Camel

The outer back Camel is the most important spin for a pairs skater to master. Because most of the combination pairs spins utilize the outer back Camel, this spin serves as the foundation for pairs spinning. Since the proper execution of this spin will determine the ability of the partners to match their relative spinning positions, it is important to master this spin without the use of toe stops.

Once the spinning position is established, there must be a constant push from the free leg and stiffening of the back and stomach muscles to make the position as strong as possible. The development of strength will allow the later introduction of more difficult positions, such as the man holding the woman above the skating surface. The strength of the spinning position and the amount of energy remaining at the conclusion of the spin outweighs the number of revolutions accomplished. Without good execution, the number of revolutions becomes worthless.

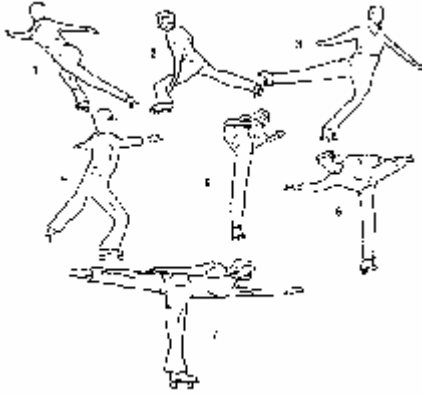

9. Shadow Spins

In modern pairs skating, shadow spins are a compulsory item. In order to attain its full potential, the team must master this type of spin. Each partner of the team must attempt to match the other as closely as possible throughout all aspects of the shadow spin—entrance position, edge quality, and the positioning of the body, arms, hands, and free legs. Since this is a very difficult aspect of the discipline, judges should award a greater degree of credit to a team who can successfully execute a shadow spin.

Only practice and a watchful eye can make the shadow spin (or any other item of content) a success. The coach will have to work many hours with the team to achieve this victory. Coach and team alike will need both discipline and determination, two important qualities in any aspect of the sport.

10. Spin Descriptions

a. Hand in Hand Upright or Camel

Both of these spins begin with the man and the woman spinning on either right outer back or left outer forward edges. During the outer back spin, the right hands will be joined; the left hands will be joined while spinning on the outer forward edge. In either position, the arms must be held firm and motionless, except around the axis of the spin. There will be a slight pull away from the partners to retain the momentum of the spin.

The position assumed in the execution of the Hand in Hand Upright will include a slightly bent skating knee, straight backs, erect heads, and straight and extended free legs with the toes pointed down and out. The exit of the spin is optional as long as good body positions are maintained.

During the execution of the Hand in Hand Camel, both bodies should be positioned in either the outer back or outer forward camel position. Good body position should be exhibited, with heads erect, backs straight, and arms extended to the sides. The free legs should be fully extended, with toes pointed down and out. The exit from this spin is optional.

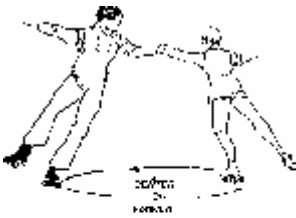

Man steps forward Man steps back



b. Pull Around Camel

This spin begins with both skaters facing forward, with the man grasping the woman's right hand with his right hand in the thumb pivot grip. As the man pulls the woman around on a right inner forward edge, she will deepen the edge and rock to an outer back edge while executing the camel position. As this occurs, the man should grasp the woman's left hip with his left hand, pulling the lady in the camel position as he steps to his right outer back and joins her in the camel position. The spinning positions of both partners should be matched, demonstrating good spinning form as previously outlined. The exit of this spin is optional.

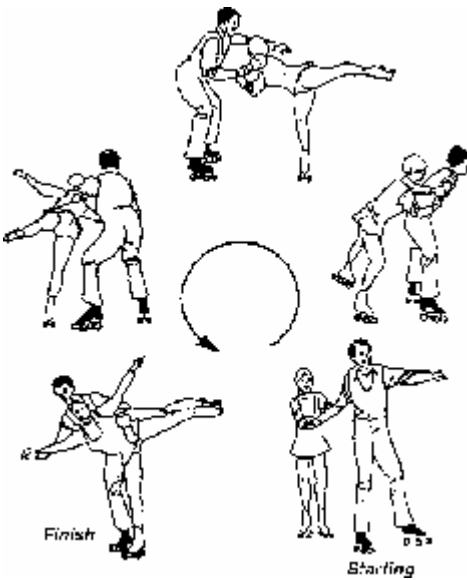

I. Pull Around Catch-Waist Camel

This spin begins in the same manner as the Pull Around Camel, except that the man rotates one-half revolution more while holding the woman's left hip with his right hand. The partners should be facing in opposite directions. The exit of this spin is optional.

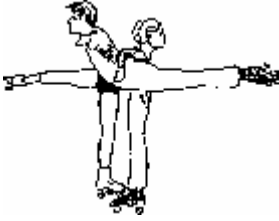

2. Pull Around Over the Head Camel

Also initiated like the Pull Around Camel, the man will complete one full revolution more than the woman by passing his left leg over the woman's body. The exit of this spin is optional.

3. Pull Around Camel Over Inverted

Done in the same manner as the Pull Around Over the Head Camel, except that the woman leans backward to the inverted position, after which the man's free leg passes over her body. The exit position of this spin is optional.

NOTE: Judges should take care to notice if the man uses his toe stop while passing his free leg over his partner's body. This is an error.



c. Tango or Face to Face Camels

Using the circle spin entrance, the woman pivots one-half turn further so that both partners will be facing the same direction. The man should be in the right inner forward camel position; the woman on the left inner back camel position. The man's right and the woman's left hands should be joined in front of the team, with the man's left hand grasping his partner's left hip. The positioning of both partners should match and good spinning posture should be evident. The exit from this spin is optional.



d. Face to Face Inner Back Sit Spin

Using the circle entrance, the partners face each other while spinning on left inner back edges, free legs extended straight back. Using both hands, the man will grasp the small of the woman's back while the woman grasps her partner's shoulders. To maintain the proper body position, the backs of both partners must remain firm as the partners lean away from each other. Backs and free legs should remain straight, with heads erect. The exit of this spin is optional.



e. Face to Face Outer Back Sit Spin

Executed the same as the Face-to-Face Inner Back Sit Spin, except that both partners will spin on right outer back edges.

f. Lay Over Camel Spin

After executing the circle entrance, both partners change to right inner forward edges as they meet. The man then changes to a right outer back camel, while the woman switches to the inverted position. It's also possible for the man to change feet at this point and perform an IB camel. The man grasps the woman at the small of the back; the woman grasps her partner's shoulders. The woman must retain control of her free leg by stretching to match the line of the man's free leg (the left side of his body should be facing upward). She must be actually spinning on an edge and supporting her body weight—not letting her skating foot drag.

NOTE: When executing the camel, the man must torque his free leg as much as possible to keep the spin moving. At the same time, he must also keep his upper body position as strong as possible to support the woman. At no time during this spin can there be any bending down by the woman or bending forward by the man. The exit is optional, but every effort should be made to finish the spin with good style.



g. Hazel Spin

After a circle entry, the partners will catch each other in a face to face position while skating on left outer forward edges. Simultaneously, the woman will change to a right inner forward edge as the man swings his right leg around and forward to a left inner back sit position. The woman should then snap to a right outer back sit in which her free leg is extended behind her. The man should grasp the small of the woman's back with both hands; the woman should grasp her partner's shoulders.

NOTE: The woman may choose to release both hands while spinning in this position.



h. Impossible Spins

Using a circle entrance, the team executes a Lay Over Camel spin, after which the man moves his right hand down to the woman's left leg and lifts her off of the skating surface. The woman must remain very rigid during the spin. To exit the spin, the woman lowers her right leg to the skating surface and both partners stand up, rolling on right outer back edges.



i. Impossible Sit Spin

Executed in the same manner as the Impossible spin, except that the man spins in a sitting position.



j. Impossible with a Twist

Accomplished as the Impossible spin, but as the woman is raised off the skating surface, she flips over and faces downward.

NOTE: The exit of all Impossible spins is optional after assuming the outer back edge position. Remember that all exiting positions should be done in good form with the heads erect, arms stretched, backs straight, and the free legs straight and fully extended.

k. Death Spiral

Both partners roll backward in a small circle. The man grasps the woman's right wrist with his right hand and leans his body back, away from the woman. When he does this, the woman also leans back. The man then bends his knees and pivots around his left toe stop. The woman's position should be pushed up at the hips, shoulder leaning down and free leg in a straight line from head to toe. Her head should be held slightly down. To complete the Death Spiral, the man pulls up on the woman's arm as she pushes with her leg to finish in a right outer back spiral position.

NOTE: It is very important for the man to maintain a steady backward pull on the woman, allowing her to hold her body position while retaining the momentum of the move.

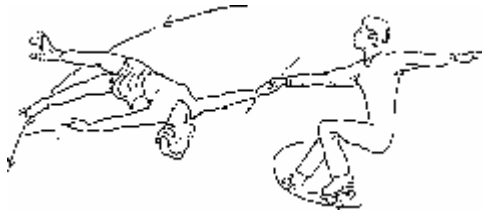

PAIRS SKATING

SECTION II - JUDGING POINTS

ARP-II-A CROSSPULLS AND FOOTWORK

Judges must score the team's ability to skate together. Pair's teams must be given higher scores if the quality of skating and unison is better, for a team cannot win on content alone. Judges must look for:

1. Unison;
2. Carriage;
3. Strength;
4. Variety of footwork;
5. Variety of hand holds;
6. Cross pulls, footwork, body motion and facial expression, which enhance the music;
7. Eye contact and emotion with one another and the audience.

The team's scoring must be reflected if weak in these areas.

ARP-II-B LIFT JUDGING POINTS

1. Toe stops must not be used by the man during any part of the lift; he should use tight, close Mohawk turns.
2. All lift take-offs by the woman must consist of recognized and accepted jump entrance techniques; two-foot take-offs should be penalized.
3. The woman must ascend from the skating surface to the apex of the lift without interruption and in a smooth, continuous manner.
4. Both partners must use equal effort on the take-offs of all lifts.
5. The woman's lift position should be executed cleanly: splitting legs to full extension and without bent knees, toes pointed, assuming a steady body position and in control throughout.
6. As long as the maximum number of allowable rotations is not exceeded, the team should receive more credit for a lift when the woman demonstrates her ability to sustain a lift position. Less credit should be awarded to any lift or part of a lift when the woman loses her position or is forced to come down early. A lift must be completed from take off to landing.
7. When executing combination lifts, each position in the combination must be held two (2) full rotations before changing to the next position.
8. The man's shoulders cannot be used to assist the woman in exiting a lift. The descent of the woman cannot be interrupted from the highest point of the lift to the final landing position.
9. Less credit shall be given to a lift if the woman taps her free foot or uses her toe stops on any lift landings.
10. If a lift attempt fails, full credit should not be given if the man lowers the woman to his shoulders and lifts her up again to save the lift. However, in only the World Class division, if the man intentionally lifts the woman to his shoulders and then lifts her overhead, this should be given full credit if executed properly. During all lifts, the man's arms must remain in the locked position.
11. Unintentional lowering of the woman by the man, thus breaking the continuity of the lift, must be penalized.
12. Twist Lutz lifts must be executed with good height and with all rotations completed in the air to receive full credit. Teams landing in a face-to-face position shall receive greater credit than those landing in a position facing the same direction.
13. On all lift landings, both partners must retain good posture, i.e. strong, straight backs, fully extended free legs, toes pointed down and out and with body positions matching as closely as possible.

14. Lift landings must also be executed as softly as possible-the woman should be placed onto the skating surface rather than letting her “free fall” to the landing position.
15. Except in the World Class division, adagio-type movements at the end of any lift are strictly prohibited.

ARP-II-C LIFTS

1. -Bucket Lift

Higher points received for:

- a. The control and speed of entrance;
- b. Girl's position with back arched and head up;
- c. Control and unison of landing.

Note: Girl landing with tight body position and back arched (no buckle at waist).
Lift must carry the floor (not spin in one spot).

Point deduction for:

- a. Unrecognized jump take offs or edge landings;
- b. Usage of boy's toe stop on the take off, rotation or landing;
- c. Incorrect body positions of either partner;
- d. Usage of girl's toe stops or dropped free leg on landing.

2. Lutz Lift

Higher points received for:

- a. The control and the speed of the entrance;
- b. Girl's position with back arched, head up and legs straight in full split with toes pointed;
- c. Control of boy's body position and rotation;
- d. Control and unison of landing.

Note: Girl landing with tight body position and back arched (no buckle at waist).
Lift must carry the floor (not spin in one spot).

Point deduction for:

- a. Unrecognized jump take offs or edge landings;
- b. Usage of boy's toe stop on the take off, rotation or landing;
- c. Incorrect body positions of either partner;
- d. Lift not fully extended;
- e. Usage of girl's toe stops or dropped free leg on landing.

3. Lutz Change Split Lift

Higher points received for:

- a. The control and the speed of the entrance;
- b. Girl's position with back arched, head up, legs straight in full split with toe pointed and no upper body movement during change of split;
- c. Control of boy's body position and rotation;
- d. Control and unison of landing.

Note: Girl landing with tight body position and back arched (no buckle at waist).
Lift must carry the floor (not spin in one spot).

Point deduction for:

- a. Unrecognized jump take offs or edge landings;
- b. Usage of boy's toe stop on the take off, rotation or landing;
- c. Incorrect body positions of either partner;
- d. Lift not fully extended;
- e. Usage of girl's toe stops or dropped free leg on landing.

4. Around the Back Lift

Higher points received for:

- a. The control and the speed of the entrance;
- b. Girl's position with back arched, head up legs straight in full split with toes pointed and girl's body position held away from boy's back;
- c. Control of boy's body position and rotation;
- d. Control and unison of landing.

Note: Girl landing with tight body position and back arched (no buckle at waist).
Lift must carry the floor (not spin in one spot).

Points deducted for:

- a. Unrecognized jump take offs or edge landings;
- b. Usage of boy's toe stop on the take off, rotation or landing;
- c. Incorrect body positions of either partner;
- d. Girl's position hanging on boy's back;
- e. Lift not fully extended;
- f. Usage of girl's toe stops or dropped free leg on landing.

5. Lutz Kick Over

Higher points received for:

- a. The control and the speed of the entrance;
- b. Girl kicks over with legs straight in full split and is extended completely over boy's head;
- c. Control of boy's body position;
- d. Control and unison of landing.

Note: Girl landing with tight body position and back arched (no buckle at waist).

Point deduction for:

- a. Unrecognized jump take offs or edge landings;
- b. Usage of boy's toe stop on take off or landing;
- c. Incorrect body position of either partner;
- d. Lift not fully extended;
- e. Sitting on boy's shoulder before descending to floor;
- f. Usage of girl's toe stops or dropped free leg on landing.

6. Airplane Lift

Higher points received for:

- a. The control and speed of entrance;
- b. Girl's position with back arched, head up and legs straight and level in full split position with toes pointed;
- c. Control of boy's body position and rotation;
- d. No hesitation in lifting girl into position over head
- e. Girl letting go with both hands (if done well);
- f. Girl rotating one-half turn with boy matching girl's landing position backwards;
- g. Control and unison of landing.

Note: In no handed position, boy must turn at least two rotations in the "let go" position to receive full credit.

Girl lands with tight body position and back arched (no buckle at waist).

Lift must carry the floor (not spin in one spot).

Point deduction for:

- a. Unrecognized jump take offs or edge landing;
- b. Usage of boy's toe stop on the take off, rotation or landing;
- c. Incorrect body positions of either partner;
- d. Lift not fully extended;
- e. Usage of girl's toe stops or dropped free leg on landing.

7. Press Lift

Higher points received for:

- a. Control and speed of entrance;
- b. Girl's position with back arched, head up, arms locked with shoulders pressing down and legs straight in split position with toes pointed;
- c. Control of boy's body position and rotation;
- d. Control and unison of landing;
- e. Kick over landing (if done poorly, must not receive high credit);
- f. If division allows it, the one handed must receive more credit if done with control and executed properly.

Note: In doing one-handed lifts, boy must turn at least two rotations in the "let go" position to receive full credit.

Girl lands with tight body position and back arched (no buckle at waist).

Lift must carry the floor (not spin in one spot).

Point deduction for:

- a. Unrecognized jump take offs or edge landings;

- b. Usage of boy's toe stop on take off, rotation or landing;
- c. Incorrect body positions of either partner;
- d. Lift not fully extended;
- e. When kick over landing is done and girl sits on boy's shoulder before landing;
- f. Usage of girl's toe stops or dropped free leg on landing.

8. Cartwheel

Higher points received for:

- a. The control and speed of the entrance;
- b. Girl's position with back arched (not hanging down boy's back), both legs straight in split position with right leg extended directly in line and above boy's head and toes pointed. When doing the lift two handed, both of girl's arms are straight;
- c. Control of boy's body position and rotation;
- d. No hesitation in lifting girl into position over boy's head;
- e. Kick over landing (if done poorly, must not receive high credit);
- f. If division allows it, the one handed must receive more credit if done with control and executed properly (no handed receives more credit than a one handed lift);
- g. Control and unison of landing.

Note: In doing one handed or no handed positions, boy must turn at least two rotations to receive full credit.

Girl landing with tight body position and back arched (no buckle at waist).

Lift must carry the floor (not spin in one spot).

Point deduction for:

- a. Unrecognized jump take offs or edge landings;
- b. Usage of boy's toe stop on take off, rotation or landing;
- c. Incorrect body positions of either partner (girl hanging down boy's back);
- d. Lift not fully extended;
- e. When kick over landing is done and girl sits on boy's shoulder before landing (except when division allows interrupted landings);
- f. Usage of girl's toe stops or dropped free leg on landing.

9. Kennedy Lift

Higher points received for:

- a. The control and speed of entrance;
- b. Girl's position—
 - (1) On two handed, back arched, head up, legs straight in split position with toes pointed down and out, and both arms locked with shoulders pressing down;
 - (2) When division allows it, the one handed team will receive more credit if done with control and executed properly. When done in layout position the legs are level with one another;
 - (3) One handed done with girl perpendicular to floor instead of layout position is much more difficult. If executed with control and ease, should receive higher credit;
- c. Control of boy's body position and rotation;
- d. No hesitation in lifting girl into position above boy's head;
- e. Control and unison of landing.

Note: In one handed or no handed position, boy must turn at least two rotations to receive full credit.

Girl lands with tight body position and back arched (no buckle at waist).

Lift must carry the floor (not spin in one spot).

Point deduction for:

- a. Unrecognized jump take offs or edge landings;
- b. Usage of boy's toe stop on take off, rotation or landing;
- c. Incorrect body positions of either partner;
- d. Lift not fully extended;
- e. Usage of girl's toe stops or dropped free leg on landing.

10. Press Chair Lift

Higher points received for:

- a. The control and speed of entrance;
- b. Girl's position—sitting up straight with back arched, head up, left leg straight extended out in front of her with toe pointed out and shoulders pressing down with arm or arms held in a controlled position;
- c. No handed chair lift receives much higher credit than a one handed if executed properly and with control. (A weak no handed should not be rewarded with high marks.)

- d. Control of boy's body position and rotation;
- e. No hesitation in lifting girl into position overhead;
- f. Control and unison of landing.

Note: In one handed or no handed position, boy must turn at least two rotations to receive full credit.

Girl landing with tight body position and arch in back (no buckle at waist).

Lift must carry the floor (not spin in one spot).

Point deduction for:

- a. Unrecognized jump take offs or edge landings;
- b. Usage of boy's toe stop on take off, rotation or landing;
- c. Incorrect body position of girl, such as bent left leg, back hunched over and a droopy right leg;
- d. Lift not fully extended;
- e. Usage of girl's toe stops or dropped free leg on landing.

11. Pancake Lift

Higher points received for:

- a. The control and speed of entrance;
- b. Girl's position with back arched with head tilted back (not looking up at ceiling), and when girl lets go with both hands;
- c. One handed receives higher credit than two handed. A weak one handed should not be rewarded with high marks.
- d. No hesitation in lifting girl into position overhead;
- e. Control of boy's body position and rotation;
- f. Control and unison of landing.

Note: In doing one handed or no handed positions, boy must turn at least two rotations to receive full credit.

Girl landing with tight body position and arched back (no buckle at waist).

Lift must carry the floor (not spin in one spot).

Point deduction for:

- a. Unrecognized jump take offs or edge landings;
- b. Usage of boy's toe stop on take off, rotation or landing;
- c. Incorrect body position of girl, such as bent knees and droopy body position;
- d. Lift not fully extended;
- e. Usage of girl's toe stops or dropped free leg on landing.

12. Milatano (most difficult lift)

Higher points received for:

- a. The control and speed of entrance;
- b. Back arched, head up and left leg extended out in front of her with toe pointed;
- c. One handed or no handed (if done weak should not be rewarded with high marks);
- d. Control of boy's body position and rotation;
- e. No hesitation in lifting girl into position overhead;
- f. Control and unison of landing.

Point deduction for:

- a. Unrecognized jump take offs or edge landings;
- b. Usage of boy's toe stop on take off, rotation or landing;
- c. Incorrect body position of either partner;
- d. Usage of boy's shoulder in lifting or in landing. Example: Girl sitting on boy's shoulder before extending into air or before descending to the floor to land. Exception: When division allows an interrupted landing (trick landing).
- e. Lift not fully extended;
- f. Usage of girl's toe stops or dropped free leg on landing.

13. Star Lift (variation of Milatano)

Higher points received for:

- a. The control and speed of entrance;
- b. Girl's position with back arched, head up and legs extended in full split with toes pointed. Left leg extended in front.
- c. No handed (if weak, should not be rewarded with high marks);
- d. Control of boy's body position and rotation;
- e. No hesitation in lifting girl into position overhead;

- f. Usage of girl's toe stops or dropped free leg in landing.

Point deduction for:

- a. Unrecognized jump take offs or edge landings
- b. Usage of boy's toe stop on take off, rotation or landing;
- c. Incorrect body position of either partner;
- d. Usage of boy's shoulder in lifting or in landing. Example: Girl sitting on boy's shoulder before extending into air or before descending to the floor to land. Exception: When division allows an interrupted landing (trick landing).
- e. Lift not fully extended;
- f. Usage of girl's toe stops or dropped free leg on landing.

14. Combination Lifts

- a. Lift must carry the floor—not spin in one spot including last change of position;
 - b. Each position should be held while boy turns two full rotations to receive full credit;
 - c. Should not be more than three changes of position overhead;
 - d. Change of positions must be done fluently. Boy must not lose his footing during any changes of position.
- Note: Combination lifts are difficult and exciting; they must be given high credit if done properly.

15. Lifts In General

- a. Must carry the floor—use as much floor surface as possible;
- b. Must be done with speed and control;
- c. Program must consist of a variety of lifts;
- d. Lifts have variations in the take offs, positions in the air and in the landings, some of which are more difficult than others. Judges must score accordingly.
- e. Lifts are a very important element of a program, but should not be over used. All divisions are limited except the World Class event. A well-balanced World Class program would contain no more than three or four lifts that carry down the floor.
- f. When doing combination lifts in program, each combination lift should be different and should not consist of same position; Example: Each combination ending in a cartwheel position or having a cartwheel position in it.
- g. Even though combination lifts are difficult and exciting, teams must show their ability to do a one-position lift with speed, control and strength. Program must consist of both types of lifts.
- h. Lifts in program should have a variety of landings. Trick landings are sometimes difficult and enhance the music, but not every lift should end with one.
- i. In choreographing a program, lifts must be laid out in different angles and go in different directions.

16. Throw Jumps

- a. Must get height and distance;
- b. Girl must not buckle at waist, drop free leg or use toe stop on landing;
- c. Boy must not stumble while throwing girl into jump;
- d. Triple receives higher credit if rotation is completed and the landing is done with control and strength.

Note: All Junior and World Class programs should contain a throw jump.
Teams with strong throw jumps must be rewarded in their scoring.

17. Twist Lift

- a. Must get height. Boy's arms are completely extended before girl starts rotation.
- b. Rotation must be completed;
- c. Girl landing backwards with boy rolling forwards instead of both rolling backwards receives higher credit for this is a more difficult way to land. Must only receive higher credit if rotation is completed and the landing is executed with strength and control. Boy should not pass the girl up or stumble over her on the landing. Both landings are correct and deserve high credit if done properly for this is a very difficult item to master.

Note: This item should be done with maximum speed and height.
All Junior and World Class programs should contain a twist lift.

ARP-II-D. SPIN JUDGING POINTS

- I. Completing solid pairs spins is an art unto itself. Unfortunately, when formulating many pairs skating programs, the value of spins is often overlooked. Well-executed pairs spins, accomplished with good body positioning, are a big asset to any pairs skating program, regardless of level. All too often, it seems that the built-in excitement of extension lifts overshadow the value of spins.

2. Good body positioning during pairs spins is frequently lacking. When executing a pairs spin, the team should strive to maintain the best possible body positions at all times. In order for the judge to fully evaluate a pairs spin, each partner should maintain the body positions involved long enough to allow the judge a clear view of the entrance edge, the spinning edges, the spinning positions (minimum of two revolutions per position), and the exit edge.
3. The body rotations of pairs camel spins should be matched so that, when executed, the pair seems a mirror image. The arch of the back and the curve of the neck should be identical, and both free legs should exit the spin position at the same time. If the woman is undersized for the man, the legs and body will not be evenly matched. When this occurs, score for artistic impression should reflect this inequity.
4. When executing a combination pairs spin, each change of position must be held for two (2) full revolutions. The change from one position to another is not counted as a revolution.
5. Use of toe stops during any part of a pairs spin, except death spiral, is a fault in execution and must be penalized.

ARP-II-E. DEATH SPIRAL

1. Entrance should start in a large circle and finish with the boy in a tight pivot;
2. Girl must keep at least three wheels on the floor to receive full credit;
3. Boy's weight should be on right skate and left toe stop. Left toe stop should be directly behind right skate with right skate pivoting around toe stop.
4. When in the tight pivot, boy should be kneeling down as far as possible. Boy should not be on all eight wheels in a spread eagle position. Boy must not use two hands to hold girl.
5. Girl's body position should be as low as possible with her head back and back arched;
6. Death spirals can be done on all edges. They should be judged on the quality of the edge and the positions of the team.

Note: All Junior and World Class programs should contain a death spiral.

ARP-II-F. SPINS

1. Entrances should be done on clean and precise edges;
2. Positions must have good bodylines to receive high credit;
3. Must spin at least three revolutions to get any credit at all;
4. In doing combination spins, each position or edge must spin at least two revolutions to get any credit at all;
5. Exits must also be clean and precise. Example: When doing pull together outer back camels and the boy spins and kicks over the girl, they must finish on a spinning edge and then exit;
6. Must not use toe stops during any part of the spinning edges. Toe stops are sometimes used during combination spins to pivot or push for speed.

Note: When doing an impossible sit, higher credit must be given when the boy comes up from the sit position into the camel position before setting the girl to the floor.

ARP-II-G. FREESKATING SPINS

The team must simultaneously perform the spins. To be given credit, the spins must start and end at the same moment and the revolutions must be the same. The spins should be judged by the same standard as for single free skating. To receive credit, both of the partners must succeed in their performance, which means that each spin must be centered on its axis, and have at least three revolutions with good body positions and in unison.

ARP-II-H. FREESKATING JUMPS

Each jump must be the same for both of the partners who have to attempt it simultaneously. Those jumps are judged by the same standard as for freeskating.

ARP-II-I PROGRAMS

1. Music and program should relate to one another;
2. Program should be balanced.

Note: A variety of areas should be used for the lifts, spins, shadow items, footwork and other items. The whole floor area should be utilized to make the program interesting.

Note: All the events leading up to World Class are limited to how many lifts, spins and shadowed items to do. It is even mandatory that they do footwork sections. World Class Pairs have no limitations. Therefore, in scoring a judge must give higher credit to a team that has shown strength in all areas of the program.

ARP-II-J MUSIC

1. The music selected for the program should blend content with artistic expression, just as the ballet piece should enhance the lifts, spins, shadow content, and footwork of a ballet. To properly reflect the artistic performance it is, the music selected by a coach or team should provide the final polish to the pairs skating program.
2. The ultimate achievement of a pairs team is to capture the attention of the audience, holding them “in the palm of their hand” from beginning to end. When a technically proficient team is regularly able to accomplish this, they have mastered their craft.
3. Musical selections, like the beat of dance music, should provide the team with a basic pattern for their footwork sequences and content items. When completed to the right music, a lift can appear twice as dynamic. The spin, which is accented by the right music, allows the viewer to “feel” the motion while viewing the spin.
4. Music emphasizes the content, footwork, and body movements; it is the ingredient, which puts the program in the perspective desired by the coach. Although music must be used in any skating program, it is seldom fully utilized. It is important for the judge be able to relate what he sees with what he hears. A team’s artistic impression score should reflect their ability to use their music effectively.
5. In competition, all recorded musical programs furnished by contestants must use the cassette tape format. Contest and championships hosts will furnish two like-quality cassette tape decks of the alternating current type. No other equipment for originating sound reproduction shall be required or furnished.

ARP-II-K CHOREOGRAPHY AND PAIRS SKATING

1. Choreography is the ability of a skater to perform arm, leg and body movements, which enhance and interpret the musical selection. The program’s music sends a message to the listener, and everyone develops a different “mental picture” of what movement’s best compliment the selection. The team’s ability to demonstrate that it can skate to the music selected for the pairs skating program is a most important component of the overall presentation. Both the judge and the spectator will favorably receive this ability.
2. The basic movements of skating—leg swings, crosses, Mohawks, one foot turns, hops and leaps may be used in different combinations to create many different segments of footwork. This footwork should also include the use of deep, strong edges designed to demonstrate the strength of the skaters and enhance each footwork segment.
3. When piecing together the program, both the phrasing and the melody of the musical selections can assist the coach in selecting the type of choreography best suited for the team. The phrasing of the music “holds” it together. If a musical count is used to arrange the steps, it should be relatively easy to come up with some good ideas in musical interpretation. The melody of the music is what you can use to arrange the series of steps in each segment of footwork. Arm and body movements may be used to enhance and define the character of these steps, but remember: Anyone can move their arms and hands to the music. Good artistic roller skaters use their skates to enhance their arm and body movements.
4. When performing any footwork segment, the body of the skater should remain on a straight body line, using knee bends to keep the motion blending with the music. Many of the formal movements found in traditional ballet and jazz blend perfectly with movements of the roller skater.
5. In most cases, the coach also serves as the choreographer. If they possess no formal knowledge of dance technique, the coach should make every attempt to understand this important aspect of the program. Without good choreography, even the most technically proficient pairs team will be incomplete, performing the best program like robots. Simply put, a pair skating without good choreography and musical interpretation is not pairs skating.

ARP-II-L SCORING PAIRS SKATING

1. The evaluation of any phase of the sport must begin with consideration of the accurate execution of the prescribed movements. This evaluation must also consider the skaters’ performance, and any evaluation of that artistic performance shall be directly dependant upon the technical elements of the program. Where music is involved, the skaters must be able to demonstrate an ability to interpret that music.

2. Pairs skating is marked in the following two areas:
 - a. Technical Merit: the content performed in the program, taking into consideration the difficulty and variety of the content, and the harmonious composition of the content within the program.
 - b. Artistic Impression: the manner in which the content is performed, taking into consideration the sureness of execution, carriage of the body (posture), and the rhythm and timing of the steps and content to the music.
 - c. When scoring a pairs skating program, judges must give equal consideration to both technical merit and artistic impression.
 - d. When assigning the score for technical merit, consideration should be given to the variety of the elements, as well as their difficulty. A well-balanced pairs skating program will include all elements of the discipline, and an overabundance of a particular type of content is considered a fault.
 - e. When assigning a score for artistic impression, consideration should be given to the interpretation of the rhythm, tempo, and mood, the projection of the ease, accomplishment and confidence of the partners, the harmonious planning, originality and inventiveness of the performance, and the unison, form, and carriage of the team.
 - f. Skaters falling on content items must be penalized in both technical merit and artistic impression. The amount of the penalty should be evaluated according to the circumstances of the fall, as demonstrated by the lack of control causing the fall. A fall is defined as “a complete loss of balance involving body contact with the skating surface.”
 - g. Skaters whose content items do not conform to the textbook definition of “complete” (i.e. cheated jumps and spins) must be penalized in both technical merit and artistic impression. A “cheated” item is defined as content with insufficient rotation, pulled take-off, or pulled landing. In no instance should the judge condone this type of content.
 - h. The judge shall give more credit to a balanced program than a program with only one area of outstanding excellence. Balance of program includes:
 - Execution of jumps, spins, and footwork of comparable difficulty
 - Musical interpretation
 - Utilization of the entire skating surface
 - Spacing of the content with the presentation

ARP-II-M EVALUATING ARTISTIC IMPRESSION

1. It is a simple fact that, to be successful, a team must devote many hours of tedious work perfecting steps and body positions that will fit their “style” of skating. Hard work and discipline are needed to create anything of lasting value.
2. Artistic Impression (manner of performance) reflects the ability of the individual to interpret the rhythm, tempo, and the mood of the program’s music. As a result, body movement and footwork sections should be designed to both conform and harmonize with the musical patterns selected for the program.
3. Another key aspect of artistic impression is the performance strength of the individual content items being performed by the team. When evaluating a program, judges and coaches alike should consider the speed, cleanness, and polish with which the items are presented. The strength and artistic ability demonstrated by the team during the lifts and spins are reflected in the scores for artistic impression score. In fact, both of these facets—individual interpretation and content strength—serve as the basis of evaluation for the Artistic Impression score.

ARP-II-N GUIDELINES FOR JUDGING WORLD CLASS PAIRS

(Reprinted from Guide for Artistic Referees, published in 1989 by the Comite International de Patinage Artistique. Distances mentioned have been converted from meters to feet.)

1. In pairs skating, the program of each routine must include the following elements:
 - a. Freeskating jumps
 - b. Freeskating spins

- c. Carry lifts
- d. Throw jumps
- e. Contact spins
- f. Death spirals
- g. Contact and freeskating footwork

2. Freeskating Jumps

- a. Each jump must be the same for both of the partners who have to attempt it simultaneously. Those jumps are judged by the same standard as for freeskating but, to receive credit, both of the partners must succeed in their performance of the jump.
- b. The jumps may be accomplished with the partners side by side or one behind the other, provided that in both cases they maintain their original distance at landing. The optimum distance should be about six feet.
- c. A higher grade shall be given to those skaters who succeed in maintaining the same technical skills and characteristics of momentum, height, travel, and body position from take off to landing.

3. Freeskating Spins

The spins must be simultaneously performed by the partners at an optimum distance of about six feet. To be given credit, the spins must start and end at the same moment and the rotations must be the same. The spins should be judged by the same standard as for freeskating. To receive credit, both of the partners must succeed in their performance, which means that each spin must be centered on its axis and have at least three rotations with good body positions and in unison.

4. Carry Lifts

- a. A Carry Lift is a movement in which the woman is held aloft above the man's head by using one or both arms extending above his head in a locked position. Less credit is given if a woman is held by the ankles, neck or under the armpits. Lifts that are done in a standing position or without rotation will receive no credit.
- b. The man may not use his toe stop during the entrance, execution and landing of a lift. No more than three rotations are permitted with the woman maintaining the same body position.
- c. A higher grade shall be given to those partners who succeed in the following elements:
 - The lift should exhibit smoothness without displaying strain. Lift affected by the support of the shoulder shall be penalized by the judges.
 - There should be good speed of rotation. Strong, artistic positions aloft.
 - Landings should be smooth and quiet with good body control. The judges shall penalize landing on the toe stop or touching the floor with the free foot.

5. Throw Jumps

- a. Throw jump means a movement in which the woman performs a recognized jump, being assisted by her partner in the take off.
- b. The landing may be affected as in the single jumps or with the woman held by her partner (twist jumps). In the latter, the position of the partners must be frontal, with the handhold on the waist. Any other position or hold may not be accepted.
- c. A higher grade shall be given to those partners who succeed in the following elements:
 - Number of turns in the air
 - Speed of the skating immediately prior to the jump
 - Height and length of the jump
 - Firm body control at the landing

6. Contact Spins

- a. A contact spin is performed by both of the partners held and maintaining the same rotation axis; the partners track one or two concentric circumferences on the floor according to the respective positions and holds. The use of toe stops is expressly prohibited in any contact spin.
- b. In spins in which the woman is lifted off the floor, the lifter must have only one foot on the floor.
- c. A higher grade shall be given to those partners who succeed in the following elements:
 - Stationary rotation axis
 - Number of rotations
 - Angular motion

- Body control and position
- Keeping on the proper edges

7. Death Spirals

- A death spiral is a particular spin in which the man pivots on his toe stop while the other skate traces a circumference on the OB edge around that center while holding the woman's hand. The woman rotates together with her partner in a layover position, holding an OB edge with her head as close to the floor as possible.
- The movement cannot be given credit when:
 - The man holds the woman with both hands
 - The man doesn't pivot, tracing a circumference around his toe stop
 - The rotation axis is not maintained
 - The man stands instead of being bent on his knees
 - The woman does not spin on the proper edge (at least three wheels on the skating surface)
- A higher grade will be given if the partners succeed in the following elements:
 - Angular motion
 - Number of rotations
 - Woman's position inverted hips (hips and shoulders facing up), with the head as close to the floor as possible
 - Man's position: bent at the knees at his partner's level
 - Firm body control at the exit of the spin

8. Contacts and Freeskating Footwork

- Footwork is steps used to connect the items of a routine. There are three types of footwork in connections with the step's intricacy:
 - Primary Footwork - not using turns;
 - Secondary Footwork - using two foot turns;
 - Advanced Footwork - using one foot turns including loops.
- Footwork may be performed while the partners are in contact with one another or while separate. It must be planned with music so as to blend each movement smoothly into the next.
- Footwork shall be valued according to the step's intricacy, smoothness and ease of performance, conformity and harmony with the musical pattern, variety and originality, identical or harmonious execution and body positions.

ARP-II-O. SPORTSMANSHIP AND PRACTICE

- Every competitive skater is striving to attain success in his or her event. Their fellow skater will never fully appreciate skaters reaching the pinnacle of success without the right attitude or knowledge of sportsmanship. Long, hard hours of practice to attain satisfaction from roller-skating will be in vain.
- Whether at practice or participating in a competition, sportsmanship plays a very important role in the sport of roller-skating. Displaying good sportsmanship — grace under pressure — is an important part of our social structure. Skaters should always display good sportsmanship, whether at the practice rink or the competition venue.

PAIRS SKATING

SECTION III - TEAM TRAINING

ARP-III-A INTRODUCTION

The basis of this section of this technical manual is to prepare both skaters and coaches for success in pairs skating. Developing a good pairs skating team takes time, and this manual is designed to improve the team in various areas over the course of the season. This seasonal projection of teaching takes the coach and the team from the beginning of the season to the final months of the competition. The ultimate goal is to prepare a championship-caliber pair for participation in a qualifying competition.

This manual also includes instructional material on pairs skating, from the most basic elements through the most advanced. It includes valuable tips on applying the “finishing touches,” as well as an insight on the judging aspects of the discipline.

ARP-III-B SELECTING THE TEAM

1. When choosing skaters for a pair’s team, as much consideration should be given to the aesthetic qualities of the team as the technical ability of the individual members. Part of creating a “true pair” is to physically match the team members as closely as possible.
2. The top of the woman’s head should be no lower than the shoulder, but no higher than the bridge of the nose of the man. In most cases, this will allow the team members to execute the content properly—the couple will be able to spin and perform lifts with ease.
3. Conditioning
It must be remembered that, in most cases, the members of a new pairs team are not adjusted to the physical demands of this aspect of the sport. Especially in the lower age groups, the activity of lifting and pulling a partner through a series of demanding moves may place a serious strain on a skater. Without proper preparation, these strains may develop into injury and further delay the development of the team.
4. Successful pairs skating (and successful skating in general) require a solid program of stretching and physical training. This must be done to develop and strengthen the appropriate muscle groups of both partners. Supervised weight training, sit ups, push-ups, leg stretches, and half squats with lightweights are all important to good physical development.
5. In all cases, a qualified professional should be consulted to ensure that the proper training program is prescribed for the individual activity involved. Coaches may also consult the USA Roller Skating Sports Medicine Manual for further information.

ARP-III-C DEVELOPING THE TEAM

A Seasonal Plan for Success

1. Like training for any other event, pairs skating development must be cultivated with discipline, nourished with knowledge and finished with growth and refinement. In order to successfully prepare a team for the rigors of competition, the season should be divided into three areas of instruction, each focusing on an important aspect of the sport.
2. The first part of the season should be devoted to analyzing the content needed to compete in the division, and then teaching techniques of the actual content, i.e. spins, jumps, side by side spins and jumps, lifts and required footwork. Mid-season should be spent developing sections of content and footwork, in addition to selecting music for the finished program. During the final part of the season, teams should accelerate their physical conditioning while striving to perfect the execution and presentation of the program itself.
3. The ideal curriculum would consist of two half-hour private lessons, one at the beginning of the week and one towards the end of the week (Monday and Friday). This instruction should be supplemented by at least four standard practice sessions of two hours duration each. Each of these two-hour sessions as a pair should be devoted only to the team and should not include practice for other individual events. Those events should be perfected at other times.
4. Aside from developing the technical aspects of the team, physical conditioning and proper mental training are the two main objectives of both coach and skaters. If the team is not properly prepared physically and mentally, a

successful end result will be in jeopardy. The desired goals are most likely achieved by positive projection by both coach and team. With the proper outlook, any desired level of success is attainable. Where pairs skating are concerned, the old adage of “the power of positive thinking” works well without a doubt. Practice sessions conducted in a positive atmosphere will produce champions, and negativity should be avoided at all costs.

ARP-III-D INSTRUCTIONAL GOALS

1. By the nature of the term, the single most important goal of a pairs team is to learn to skate together. By learning the correct techniques, developing strong unison and working hard on the consistent matching of body positions during the execution of the content, a pair skating team will blossom into a championship-level couple.
2. When selecting content, a series of team goals should be developed. These goals will encourage the team to focus their skating activities and act as a reward when the desired level of execution has been reached. The coach when setting these goals, since it is a fact that no two people learn at the same rate should take care. Some learn at a gradual pace, some accelerate and then level off, and some just can't learn fast enough. Since each student possesses a different ability to learn, the coach must find a way to get through to the students so goals for the team are accomplished. In all cases, regardless of ability, patience, strength and understanding are required to produce successful skaters.

ARP-III-E DEVELOPING TEAM ABILITY

1. Content, the technical execution of the items, which comprise a pairs skating program, is something, which must be taught with patience and confidence. The coach should do everything possible to ensure that the skater is properly executing the jumps, spins, and lifts in the manner required by USA Roller Skating.
2. The cycle of development for a successful pairs skating team is one of constant evolution. When the team is introduced to overhead lifts, the man may encounter difficulty in raising the woman to the desired level, possibly being able to raise her only halfway. By the end of the season, however, the man should be able to lift the woman to the full extension position.
3. The same holds true for the execution of spins. When the team first begins working on the spins, they may only be able to spin together for a single rotation. By the end of the season, and with a lot of practice, the team should advance enough technically to be able to spin a minimum of three revolutions. No matter what the division or the level of the content, don't settle for less than the highest attainable level of technical proficiency!

ARP-III-F BASIC UNISON

1. When properly performed, pairs skating are the most spectacular event of artistic roller-skating. This is dictated by the important factor upon which pairs skating is based —unison of motion.
2. Motion is the one item, which makes things appear spectacular. Body motion blends body and music together. Motion is an important concept in skating. Through the successful and efficient completion of spectacular moves, the pair's team captures the attention of judges and spectators alike.
3. Unison is the ability of the team to make two bodies appear as one. When one partner assumes an arm position, the other partner should duplicate the move. To correctly interpret and perform a pairs skating program, a team should strive to match all movements of the head, arms, legs, etc. Unison is also the matching landing positions, spinning positions, and footwork sequences. Every effort on the part of the team should be to act as one being. Successful unison is the “finishing touch” to a good pairs skating program.
4. In order to achieve this unique quality, the team must spend many hours developing unison with one's partner. During general skating, such as cross pulls forward and backward, the partner's bodies must match in every way possible: from the arch of the back to the positions of the arms and legs. Good unison is the difference between two people skating together and a championship pairs team.
5. When beginning a new team, the coach must first stress the importance of unison. Before spending a moment on content, the team should concentrate on working through all the basic pairs skating positions and performing them with ease. There are many useful and effective ways to develop team unison. A few of the more simple ones involve basic skating movements, which are used at every practice session.

ARP-III-G CIRCLE DRILLS

1. Instructing the team to perform circular skating exercises, both forward and backward in both directions, can do much to generate a sense of unison between the partners. Another deviation of the circle drill, the figure eight drill, is also a good unison-builder. The figure eight drill consists of two circle drills with a connecting edge across the center of the skating surface. Once again, the direction of travel should be alternated to obtain the maximum benefit.

2. During either of these drills (or any drill) it is important for each team member to attempt to match every step and position with their partner. In fact, regardless of the task or exercise, the coach should work in as many opportunities as possible to generate team unison. From practice session to lesson to competition, the team should learn to think and move as one.

ARP-III-H CONTENT

1. Well-balanced pairs skating programs should contain individual and pairs jumps and spins, overhead lifts, throw jumps, death spirals, and segments of individual and pairs footwork. If there is to be an overabundance of any type of content, it should be movements, which involve the partners in contact. However, no pair skating performance is complete until each member of the team demonstrates his or her individual free skating ability.
2. The value of footwork in pair skating programs can be measured by the fact that quality footwork performed with speed is one of the major components of the program. It is considered of equal importance with the lifts, spins and jumps.

ARP-III-I DIFFICULTY

In a competitive skating program, relative standards of difficulty should be uniformly applied throughout the program. The performance should not be “stacked” with obvious high points, such as a concentration of lifts with multiple positions—well-performed pairs spins are of equal value to any lift. Each member of the team should demonstrate his or her ability to perform all the prescribed content for his or her competitive division.

ARP-III-J MUSICAL SELECTION

A program choreographed with the musical selection must receive a higher rating for difficulty than a similar program in which the music is simply a background filler. It must be noted that greater difficulty is achieved when both partners move together in complete harmony, showing a marked degree of pairs unison, and excellent expression of the mood and rhythm of the music and the change of pace. There should be a definite change of pace in the music in the skating, demonstrating interpretive abilities.

ARP-III-K VARIETY

The variety in the program should consist of more than the use of different lifts, spins, Freeskating and other content items. The program should also exhibit variety in the performance of the items involved, such as different entry and exit edges for spins, overhead lifts, and jumps.

ARP-III-L HARMONIOUS COMPOSITION

Championship-caliber pairs programs should exhibit good basic form and be presented with style, rhythm, grace and sureness. The entire skating surface should be utilized, and athletic and aesthetic ability and variety should be demonstrated throughout.